

PREVIEW 2021

Poliform

Poliform

Poliform presenta in anteprima i nuovi prodotti dedicati alla zona giorno e alla zona notte. Divani, sedute e poltrone dove design e comfort trovano il perfetto equilibrio, tavolini che spiccano per l'aspetto scultoreo e una collezione notte che celebra il legame stilistico tra i diversi ambienti della casa, reinterpretando l'estetica di Poliform in chiave lifestyle – tra qualità del design, armonia delle forme, eccellenza dei materiali e saper fare.

Poliform reveals the new products dedicated to the day area and night area. Sofas, chairs, and armchairs where design and comfort find the perfect balance, coffee tables that stand out for their sculptural look, and a night collection that celebrates the stylistic link between the various environments of the house, reinterpreting Poliform's signature style as a lifestyle – between quality of design, harmony of shapes, excellence of materials, and know-how.

2021

Insieme ai nuovi prodotti, Poliform racconta una nuova idea di stile – più morbida e contemporanea. Jean-Marie Massaud reinterpreta il living come un paesaggio domestico fatto di forme organiche e linee curve: il sistema Saint-Germain e la poltrona Le Club, affiancati dai tavolini-scultura Koishi e Orbit, trasformano ogni spazio in un luogo privato di comfort e intimità. Si amplia la collezione Seattle, che si arricchisce dello sgabello. Marcel Wanders trasporta le atmosfere della Gentleman Collection nella zona notte, traducendo l'ispirazione classica di poltrone e divani in una capsula composta di letto, comodino e comò. E se il design si fa più morbido, riacquistano centralità le sensazioni tattili, veicolate da tappeti, coperte e nuovi tessuti.

Together with the new products, Poliform tells the story of a new idea of style – softer and more contemporary. Jean-Marie Massaud reinterprets the living room as a domestic landscape made of organic shapes and curved lines: the Saint-Germain system and the Le Club armchair, joined by the Koishi and Orbit sculpture-coffee tables, transform every space into a private place of comfort and intimacy. The Seattle collection expands, enriched by the stool. Marcel Wanders transports the atmosphere of the Gentleman Collection into the night area, translating the classic inspiration of armchairs and sofas into a capsule composed of bed, night table, and chest of drawers. And while the design becomes softer, the tactile sensations regain focus through carpets, blankets, and new fabrics.

COLLECTIONS

| | |
|----------------------------|-----|
| SAINT-GERMAIN SOFA | 9 |
| KOISHI COFFEE TABLE | 47 |
| LE CLUB ARMCHAIR | 63 |
| ORBIT COFFEE TABLE | 81 |
| SEATTLE STOOL | 93 |
| GENTLEMAN NIGHT COLLECTION | 105 |
| RELIEF – CANNELÉ CARPETS | 125 |
| LINUS BLANKET | 133 |
| SAINT-GERMAIN COMPOSITIONS | 139 |
| TECHNICAL DATA | 173 |

SAINT-GERMAIN

Saint-Germain è un sistema di divani ed elementi imbottiti dalle forme sinuose e sensuali. Un segno avvolgente e rotondo ricorre in tutti i moduli della serie, con cui si creano divani lineari, configurazioni a L o composizioni organiche. Il rivestimento, in tessuto o pelle, valorizza i volumi, pieni e voluttuosi. Progettato da Jean-Marie Massaud, Saint-Germain trasforma qualsiasi spazio in un paesaggio caldo e familiare, infondendo una piacevole sensazione di comfort domestico.

Saint-Germain is a system of sofas and upholstery elements with sinuous and sensual shapes. An enveloping and round style recurs in all the modules of the series, which features linear sofas, L-shaped configurations, or organic compositions. The covering, in fabric or leather, enhances the volumes, full and voluptuous. Designed by Jean-Marie Massaud, Saint-Germain transforms any space into a warm and familiar landscape, giving a pleasant sensation of domestic comfort.







Nella pagina introduttiva: dettaglio del divano Saint-Germain, rivestimento sfoderabile in tessuto Siro 01 bianco. Qui e nella pagina precedente: divano Saint-Germain, rivestimento sfoderabile in tessuto Agadir 06 ocra, cuscini in velluto Persia 1404 carbone, piedini brown nickel opaco. Accanto al divano, tavolini Koishi, entrambi con piano in olmo nero e struttura verniciato brunito. Al centro, tavolini Koishi, versione grande con piano in vetro blu riflettente, versione piccola con piano in pietra ebano spatolata, entrambi con struttura verniciato brunito. Nella pagina a sinistra: dettaglio del tavolino Koishi inseribile tra due elementi del divano, piano in pietra ebano spatolata e struttura verniciato brunito.

Introduction page: close up of the Saint-Germain sofa, removable cover in fabric Siro 01 bianco. Here and previous page: Saint-Germain sofa, removable cover in fabric Agadir 06 ocra, cushions in velvet Persia 1404 carbone, mat brown nickel feet. Next to the sofa, Koishi coffee tables, both with top in black elm and structure painted brunito. In the centre, Koishi coffee tables, big version with top in blu reflecting glass, small version with top in ebony stone with spatula finish, both with structure painted brunito. Left page: close up of the Koishi coffee table, which can be inserted between two elements of the sofa, top in ebony stone with spatula finish and structure painted brunito.



Qui e nella pagina precedente: divano Saint-Germain in tessuto sfoderabile Agadir 06 ocra, cuscini in velluto Persia 1404 carbone e in tessuto Nancy 101 carbone, piedini brown nickel opaco. Tavolini Koishi, piani in vetro blu riflettente, marmo zecevo levigato, pietra ebano spatolata con struttura verniciato brunito. Tavolini Orbit in vetro bronzato. Composizione sospesa Code retroilluminata in laccato metallico bronzo, vani a giorno in laccato opaco bronzo e schienali in rovere gold. Poltrone Le Club in pelle non sfoderabile Silk 06 roccia. Tappeto Cannelé.

Here and previous page: Saint-Germain sofa in removable fabric Agadir 06 ocra, cushions in velvet Persia 1404 carbone and in fabric Nancy 101 carbone, mat brown nickel feet. Koishi coffee tables, tops in blu reflecting glass, mat marble zecevo, spatula finish ebony stone with brunito painted structure. Orbit coffee table in bronzed glass. Wall mounted backlite Code composition in metal lacquer bronzo, open compartments in mat lacquer bronzo and backs in gold oak. Le Club armchairs in non-removable leather Silk 06 roccia. Carpet Cannelé.





Qui, nella pagina precedente e nella successiva: divano Saint-Germain, rivestimento sfoderabile in pelle Nabuk 01 latte, cuscini in tessuto Brest 04 pepe e in velluto Persia 1404 carbone, piedini brown nickel opaco. Nella successiva: poltrone Le Club in tessuto non sfoderabile Agadir 09 giada. Tavolini Koishi, piani in marmo sahara noir levigato e olmo nero, struttura verniciato brunito. Tavolini Orbit in vetro bronzato. Tavolino Dama in massello noce canaletto. Composizione Wall System in laccato opaco canapa e olmo nero, nella parte superiore griglie e schienali in laccato metallico ottone, schienale centrale in laccato lucido canapa, luce a led integrata. Tappeto Relief perla.

Here, previous and following page: Saint-Germain sofa, removable cover in leather Nabuk 01 latte, cushions in fabric Brest 04 pepe and in velvet Persia 1404 carbone, mat brown nickel feet. Following page: Le Club armchairs in non-removable fabric Agadir 09 giada. Koishi coffee tables, tops in mat marble sahara noir and black elm, painted brunito structure. Orbit coffee tables in bronzed glass. Dama coffee table in solid walnut Canaletto. Wall System composition in mat lacquer canapa, black elm and metal lacquer ottone, central upper back in glossy lacquer canapa, integrated led light. Carpet Relief perla.

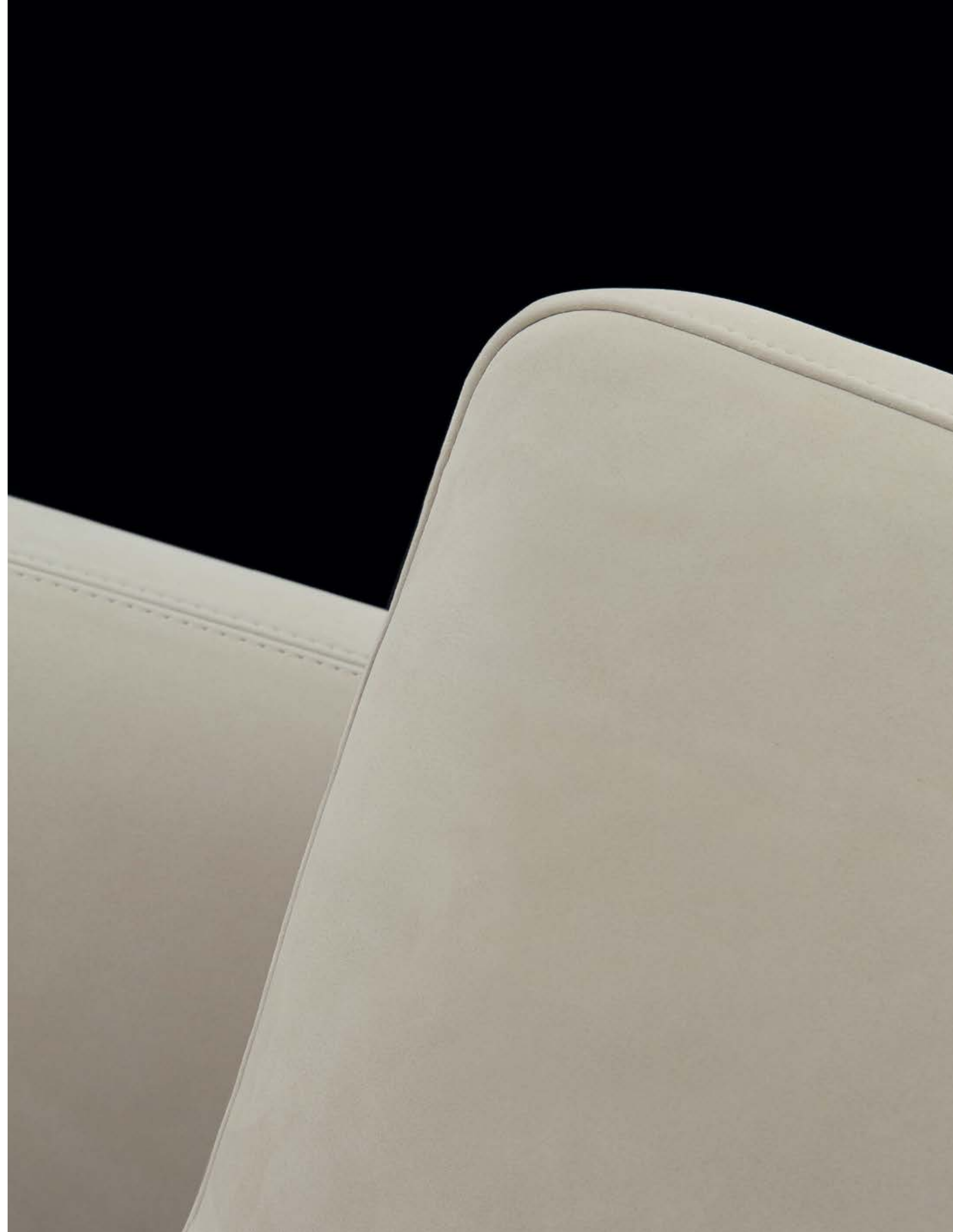







Qui e nella pagina precedente: divano Saint-Germain, rivestimento sfoderabile in tessuto Siro 01 bianco, cuscini in tessuto Brest 11 cioccolato e in velluto Persia 2020 bruciato, piedini brown nickel opaco. Accanto al divano, tavolino Koishi con piano in vetro blu riflettente e struttura champagne opaco. Al centro, tavolino Koishi con piano in marmo zecevo levigato e struttura champagne opaco.

Here and previous page: Saint-Germain sofa, removable cover in fabric Siro 01 bianco, cushions in fabric Brest 11 cioccolato and in velvet Persia 2020 bruciato, mat brown nickel feet. Next to the sofa, Koishi coffee table with top in blu reflecting glass and mat champagne structure. In the centre, Koishi coffee table with top in mat marble zecevo and mat champagne structure.



Qui e nella pagina precedente: divano Saint-Germain in tessuto sfoderabile Siro 01 bianco, cuscini in tessuto Brest 11 cioccolato e in velluto Persia 2020 bruciato, piedini brown nickel opaco. Pouf Saint-Germain in tessuto sfoderabile Siro 01 bianco con piedini brown nickel opaco. Tavolini Koishi, piani in marmo zecevo levigato e vetro blu riflettente, struttura champagne opaco. Poltrona Le Club in pelle non sfoderabile Silk 01 crema. Madia Code in noce gold con top in laccato metallico bronzo, vano a giorno in laccato opaco bronzo e basamento con piedini ardesia opaco. Tappeto Relief cammello.

Here and previous page: Saint-Germain sofa in removable fabric Siro 01 bianco, cushions in fabric Brest 11 cioccolato and in velvet Persia 2020 bruciato, mat brown nickel feet. Saint-Germain pouf in removable fabric Siro 01 bianco with mat brown nickel feet. Koishi coffee tables, tops in mat marble zecevo and blu reflecting glass, mat champagne structure. Le Club armchair in non-removable leather Silk 01 crema. Code sideboard in gold walnut with top in metal lacquer bronzo, open compartment in mat lacquer bronzo and base with mat ardesia feet. Carpet Relief cammello.





Qui e nella pagina precedente: divano Saint-Germain, rivestimento sfoderabile in tessuto Lima 67 pernice, cuscini in velluto Glasgow 03 carbone, piedini brown nickel opaco.

Here and previous page: Saint-Germain sofa, removable cover in fabric Lima 67 pernice, cushions in velvet Glasgow 03 carbone, mat brown nickel feet.





In questa pagina: pouf Saint-Germain, versione grande in pelle sfoderabile Deep 02 sabbia, versione piccola in tessuto sfoderabile Brest 12 sabbia, entrambi con piedini brown nickel opaco.

This page: Saint-Germain pouf, big version in removable leather Deep 02 sabbia, small version in removable fabric Brest 12 sabbia, both with mat brown nickel feet.

In questa pagina: dettaglio dei pouf Saint-Germain, rivestimento sfoderabile in pelle Deep 02 sabbia e in tessuto Brest 12 sabbia, piedini brown nickel opaco.

This page: close up of the Saint-Germain pouf, removable cover in leather Deep 02 sabbia and in fabric Brest 12 sabbia, mat brown nickel feet.

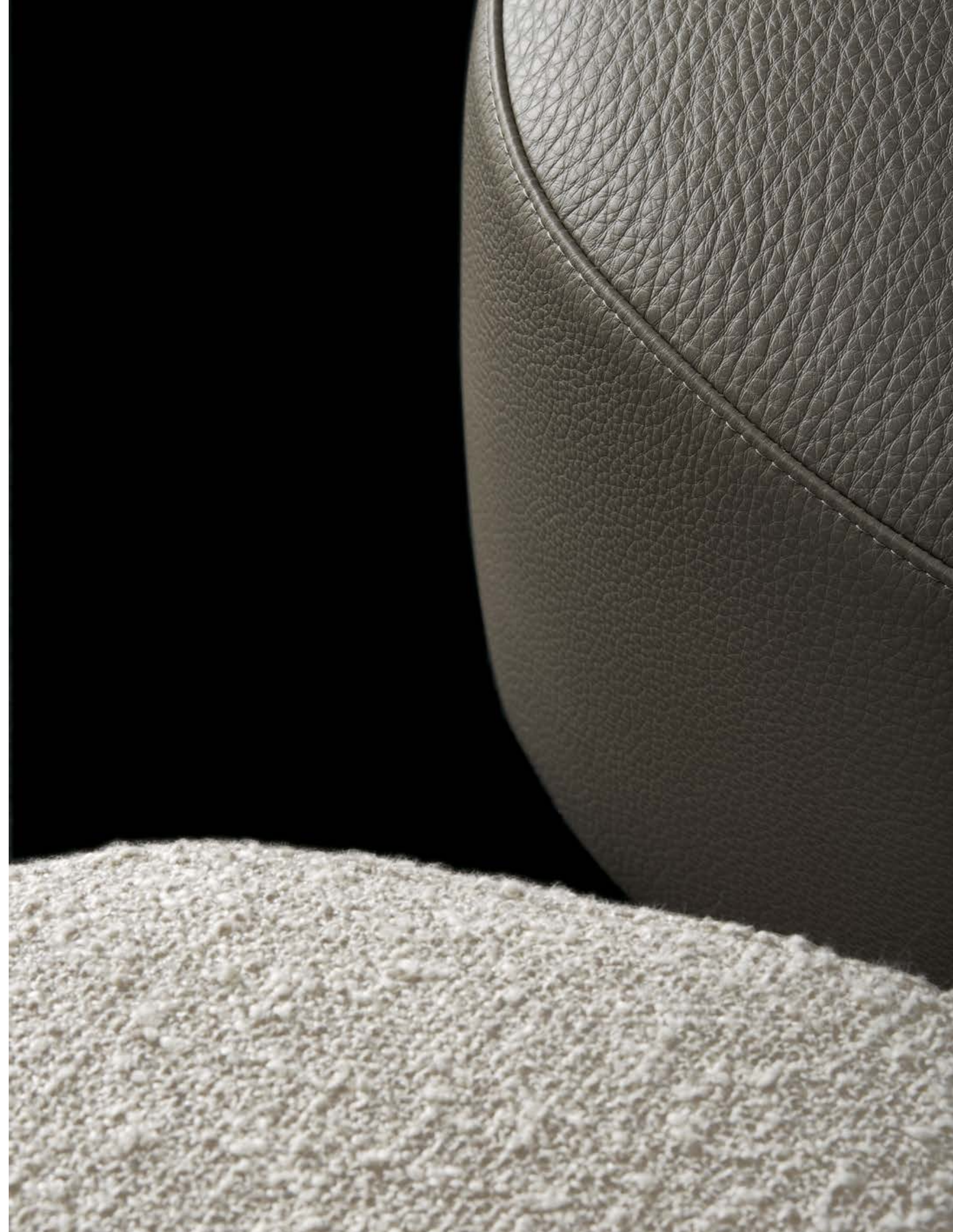

SAINT-GERMAIN

Design Jean-Marie Massaud

Struttura in legno e derivati. Schienale in poliuretano flessibile stampato, cuscino seduta in poliuretano espanso a quote differenziate, prerivestimento in tela cotone e piuma.

Cuscino schienale in poliuretano espanso e piuma, larghezza mm 600-700-800.

Cuscino poggiatesta in strutturato e piuma.

Cuscini opzionali in tela cotone e piuma.

Piedini regolabili in metallo verniciato brown nickel opaco.

Rivestimento sfoderabile in tessuto o pelle.

Tavolino Koishi inseribile tra due elementi

con struttura in metallo verniciato brunito

o champagne opaco. Piano in olmo nero,

rovere gold, vetro blu riflettente, pietra ebano

spatolata o sei marmi levigati e sei lucidi.

Structure in wood and wood by-products.

Backrest in flexible moulded polyurethane, seat cushion in multi-density polyurethane foam, pre-cover in cotton canvas and down.

Fixed backrest cushion in polyurethane

foam and down, width 23 1/2"-27 1/2"-31 1/2".

Structural headrest cushion and down.

Optional cushions in cotton canvas and down.

Levelling feet in painted metal mat brown

nickel.

Removable cover in fabric or leather.

Koishi coffee table to be inserted between

two units, with structure in metal painted

brunito or mat champagne. Top in black elm,

gold oak, blu reflecting glass, ebony stone

with spatula finish or six mat and six glossy

marbles.

Esempi divani composti Examples of modular sofas

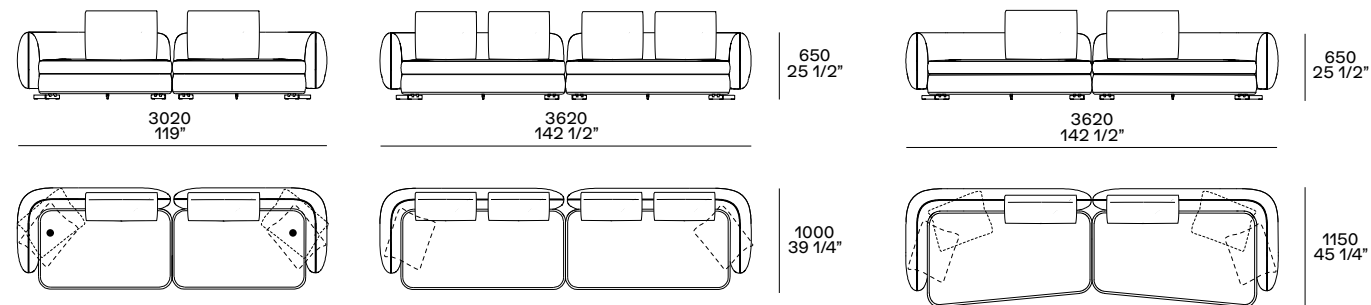

Cuscini poggiatesta opzionali Optional headrest cushions

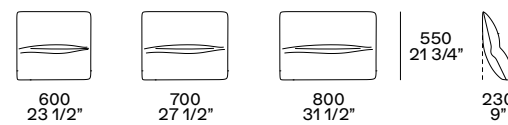

Cuscino strutturale (h 600) più alto del cuscino schienale fisso. Può sostituire il cuscino schienale fisso della misura corrispondente e solo dove indicato, i cuscini opzionali.

Structural cushion (h 23 1/2") higher than the fixed backrest cushion. It can replace the fixed backrest cushion in the corresponding size and, only where indicated, the optional cushions.

Cuscini opzionali Optional cushions



● cuscino poggiatesta opzionale l 600
optional headrest cushion w 23 1/2"

■ cuscino poggiatesta opzionale l 700
optional headrest cushion w 27 1/2"

cuscino opzionale 500×500
optional cushion 19 3/4"×19 3/4"

cuscino opzionale 550×580
optional cushion 21 3/4"×22 3/4"

Divano Sofa

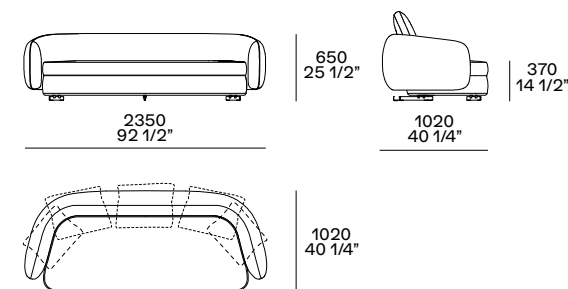

Elementi freestanding sx-dx Lt-rt freestanding elements

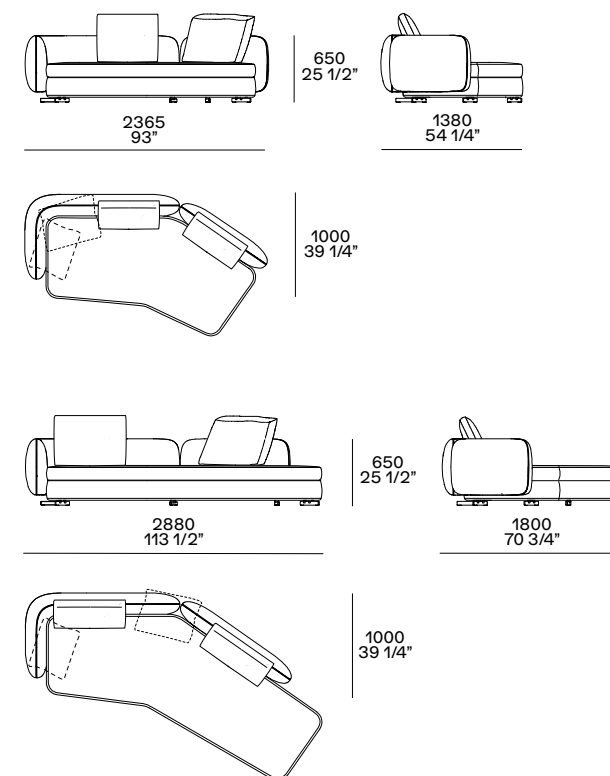

Divano Boomerang sx-dx Lt-rt Boomerang sofa

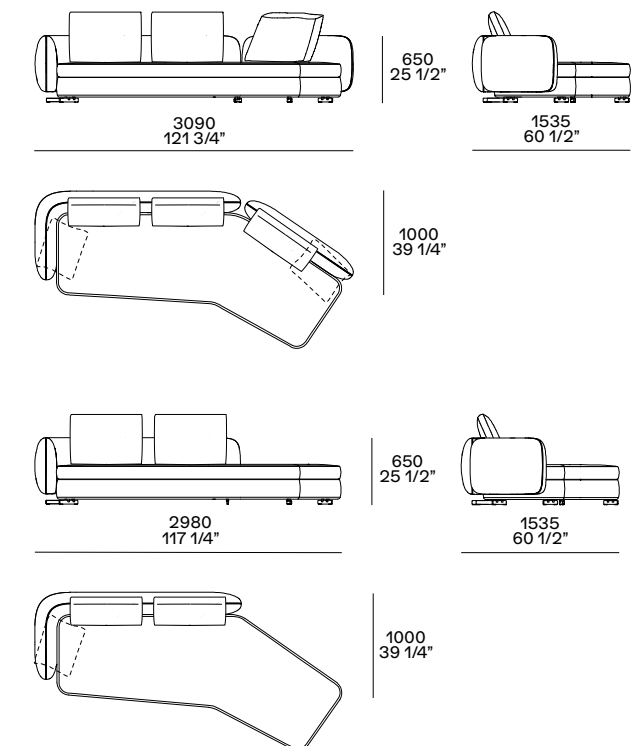
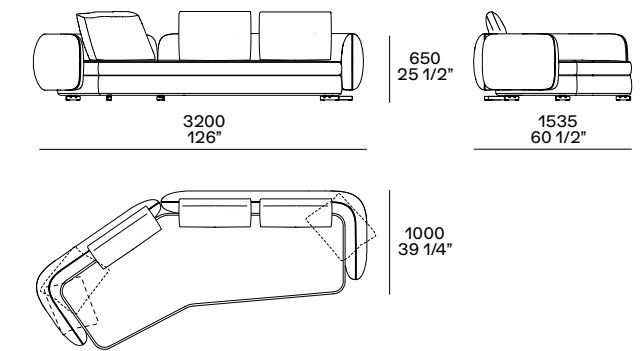

Pouf centrostanza Freestanding pouf

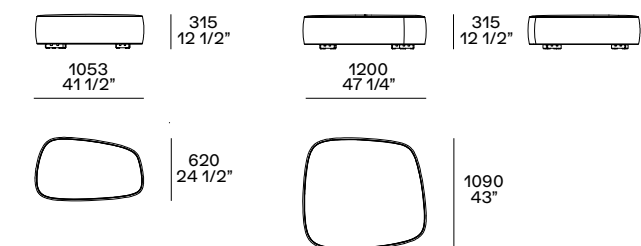

**Terminale sx-dx
Lt-rt end unit**

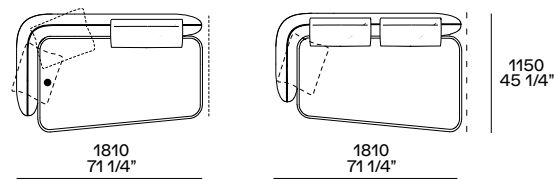
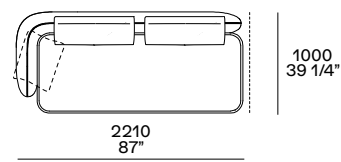
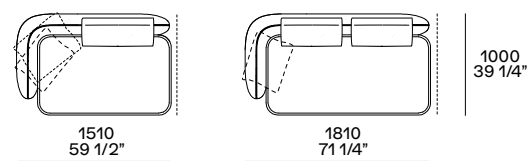

**Terminale inclinato sx-dx
Lt-rt angled end-unit**

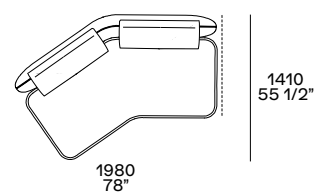
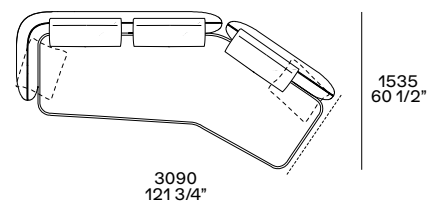
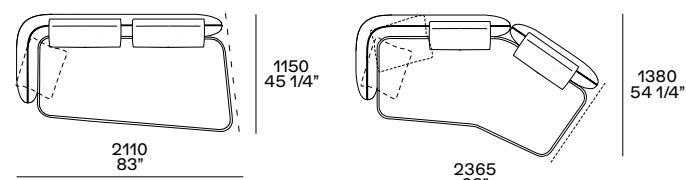

anche uso centrale
also central unit

profondità 1000 - seduta 790
depth 39 1/4" - seat 31"

profondità 1150 - seduta 940
depth 45 1/4" - seat 37"

• cuscino poggiatesta opzionale I 600
optional headrest cushion w 23 1/2"

■ cuscino poggiatesta opzionale I 700
optional headrest cushion w 27 1/2"

**Terminale penisola sx-dx
Lt-rt peninsula end unit**

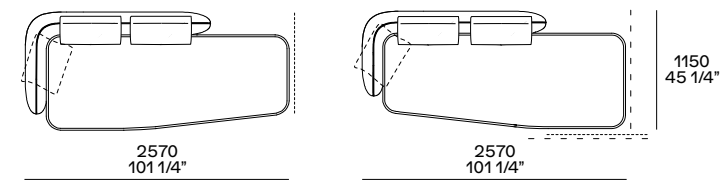
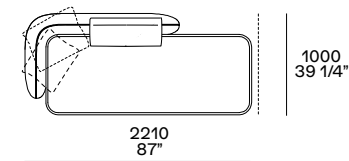

**Terminale penisola inclinato sx-dx
Lt-rt angled peninsula end unit**

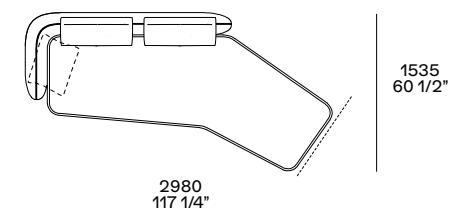
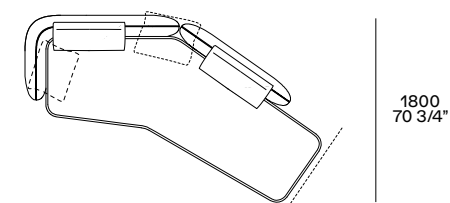
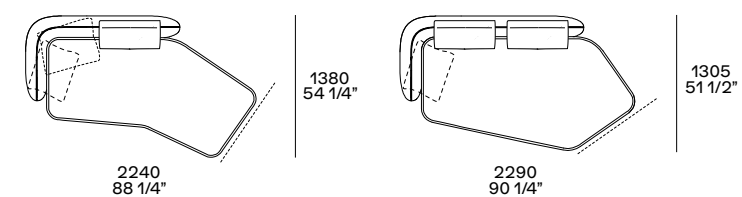

cuscino opzionale 500×500
optional cushion 19 3/4"×19 3/4"



cuscino opzionale 550×580
optional cushion 21 3/4"×22 3/4"

**Centrale
Central unit**

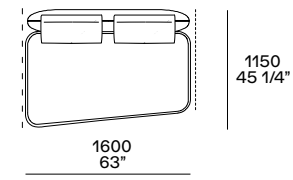
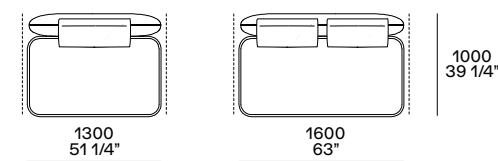

**Centrale inclinato sx-dx
Lt-rt angled central unit**

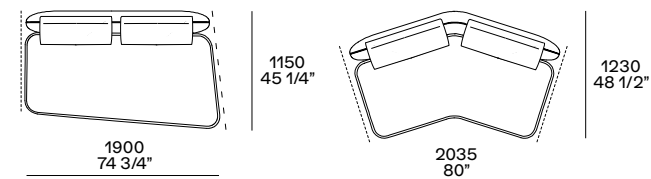

anche uso terminale
also end unit

**Penisola sx-dx
Lt-rt peninsula**

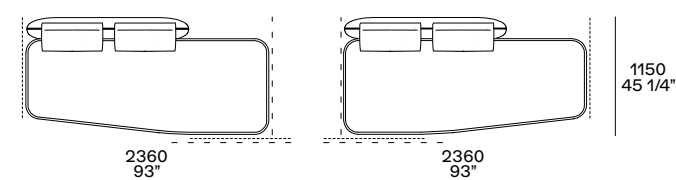
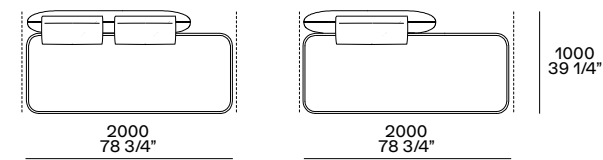

anche uso centrale o angolare
also central unit or corner unit

**Chaise longue sx-dx
Lt-rt chaise longue**

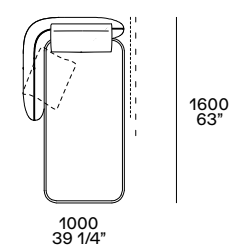

**Chaise longue inclinata sx-dx
Lt-rt angled chaise longue**

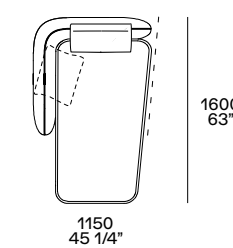

accostabile solo al terminale inclinato I 2110
to be put next to the angled end-unit only w 83"

**Angolo sx-dx
Lt-rt corner unit**

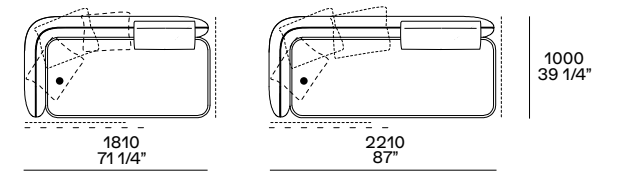
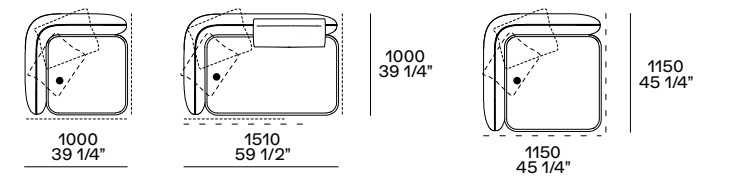

**Angolo inclinato sx-dx
Lt-rt angled corner unit**

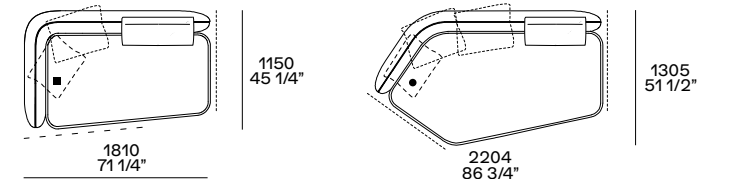

accostabile solo al centrale inclinato I 1900 e al terminale inclinato I 2110
to be put next to the angled central unit
w 74 3/4" and to the angled end unit w 83" only

**Angolo penisola sx-dx
Lt-rt peninsula corner unit**

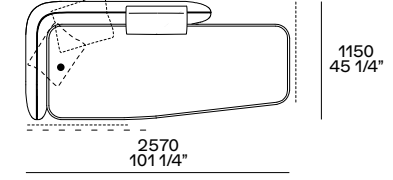

**Angolo penisola inclinato sx-dx
Lt-rt angled peninsula corner unit**

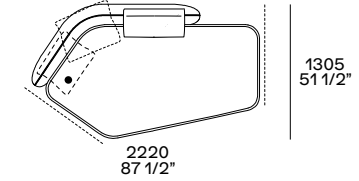

**Tavolino Koishi
Koishi coffee table**

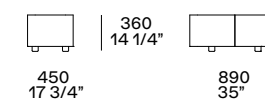

da inserire tra due elementi
to be inserted between two units

KOISHI

Pensati come naturale complemento del sistema Saint-Germain per le forme organiche e la pacata eleganza, i tavolini Koishi accompagnano con personalità tutti i divani e le poltrone della collezione. La struttura in metallo, scultorea ma essenziale, sostiene il top prezioso in pietra ebano, marmo, vetro riflettente o essenza.

Designed as natural complements to the Saint-Germain system for their organic shapes and quiet elegance, the Koishi coffee tables accompany with personality all the sofas and armchairs in the collection. The sculptural yet minimalist metal structure supports the precious top in ebony stone, marble, reflective glass, or wood.

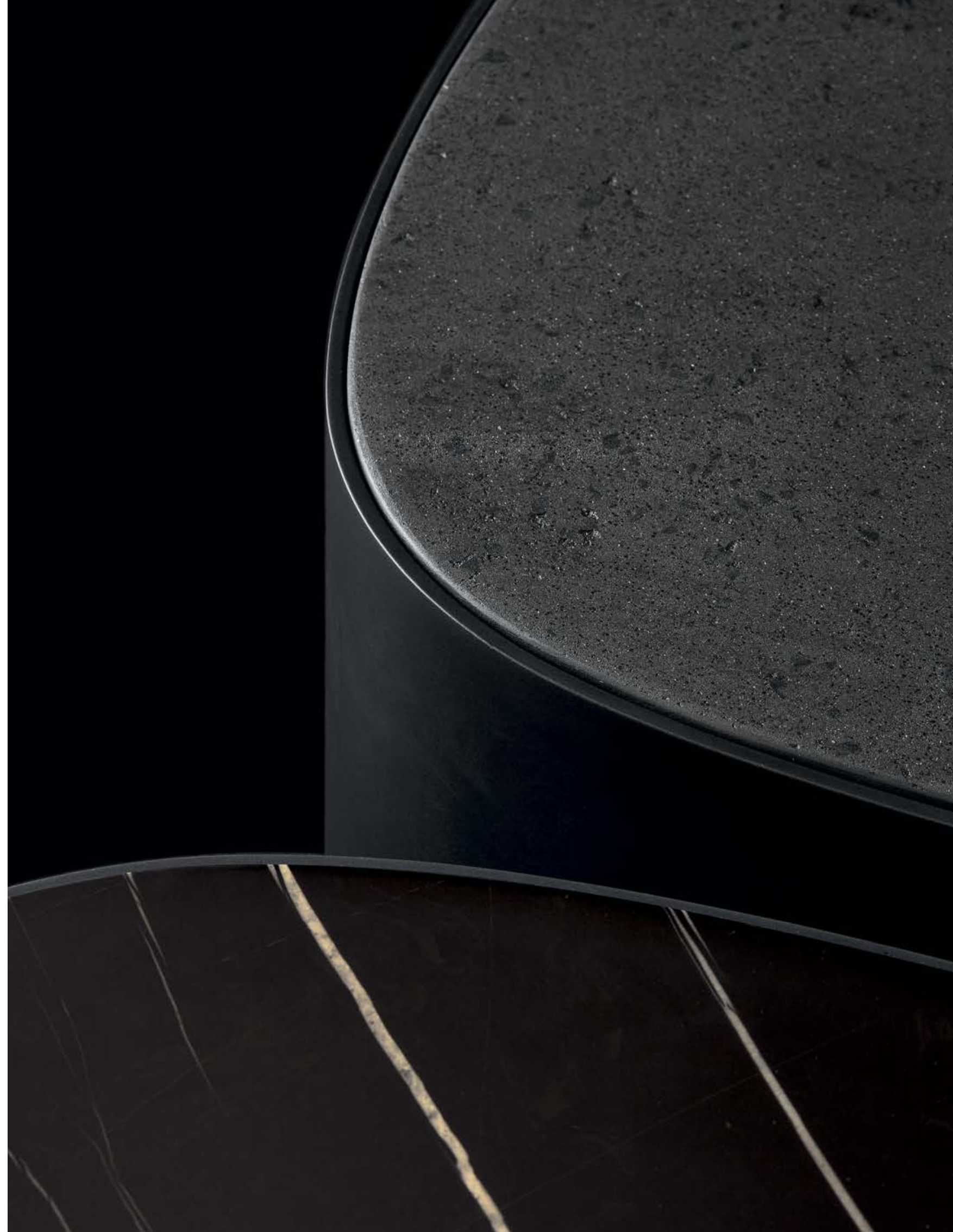





Nella pagina introduttiva: tavolino Koishi, piano in marmo zecevo levigato e struttura champagne opaco. Nelle precedenti: tavolini Koishi, versione grande con piano in marmo sahara noir levigato, versione piccola con piano in pietra ebano spatolata, entrambi con struttura verniciato brunito. In questa pagina: tavolini Koishi, piano in olmo nero e marmo zecevo levigato, struttura verniciato brunito. Nella pagina successiva: divano Saint-Germain in pelle sfoderabile Nabuk 01 latte, cuscini in tessuto Brest 04 pepe e in velluto Persia 1404 carbone, piedini brown nickel opaco. Poltrone Le Club in tessuto non sfoderabile Agadir 09 giada. Tavolini Koishi, piani in marmo sahara noir levigato e olmo nero, struttura verniciato brunito. Composizione Wall System in laccato opaco canapa e olmo nero, nella parte superiore griglie e schienali in laccato metallico ottone, schienale centrale in laccato lucido canapa, luce a led integrata. Tappeto Relief perla.

Introduction page: Koishi coffee table, top in mat marble zecevo and structure mat champagne. Previous pages: Koishi coffee tables, big version with top in mat marble sahara noir, small version with top in ebony stone with spatula finish, both with structure painted brunito. This page: Koishi coffee tables, top in black elm and mat marble zecevo, structure painted brunito. Following page: Saint-Germain sofa in removable leather Nabuk 01 latte, cushions in fabric Brest 04 pepe and in velvet Persia 1404 carbone, mat brown nickel feet. Le Club armchairs in non-removable fabric Agadir 09 giada. Koishi coffee tables, tops in mat marble sahara noir and black elm, structure painted brunito. Wall System composition in mat lacquer canapa and black elm, in the upper part grids and backs in metal lacquer ottone, central back in glossy lacquer canapa, integrated led light. Carpet Relief perla.





Nella pagina precedente: pouf Saint-Germain in tessuto sfoderabile Brest 02 sabbia, piedini brown nickel opaco. Tavolini Koishi con piano in marmo zecevo levigato e struttura champagne opaco. Qui e nella pagina successiva: tavolini Koishi, piano in vetro blu riflettente e struttura champagne opaco, piano in marmo zecevo levigato e struttura verniciato brunito.

Previous page: Saint-Germain pouf in removable fabric Brest 02 sabbia, mat brown nickel feet. Koishi coffee tables with top in mat marble zecevo and mat champagne structure. Here and following page: Koishi coffee tables, top in blu reflecting glass and mat champagne structure, top in mat marble zecevo and structure painted brunito.





KOISHI

Design Jean-Marie Massaud

Struttura in metallo verniciato brunito o champagne opaco. Piano in olmo nero, rovere gold, vetro blu riflettente, pietra ebano spatolata o sei marmi levigati e sei lucidi.

Structure in metal painted brunito or mat champagne. Top in black elm, gold oak, blu reflecting glass, ebony stone with spatula finish or six mat and six glossy marbles.

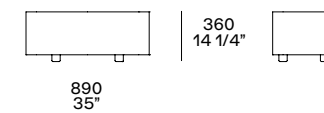
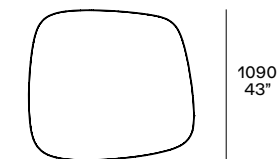
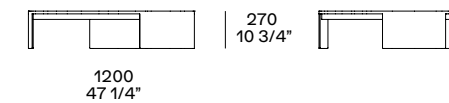
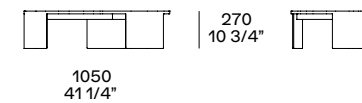
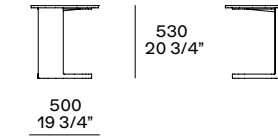
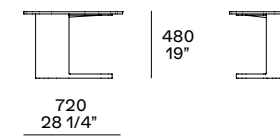

Da utilizzare tra due elementi del divano.
To be inserted between two sofa units.

LE CLUB

Ispirata alle voluminose poltrone in cuoio dei club del secolo scorso, Le Club reinterpreta in chiave contemporanea uno degli archetipi del design. Nessun compromesso sul comfort né sulla qualità dell'esecuzione per una poltrona che alleggerisce le forme e i materiali, all'insegna di un'eleganza più disinvolta. Fra artigianalità e tecnologia, Le Club è destinata a non subire il passare del tempo, nuova icona di spazi domestici e luoghi istituzionali.

Inspired by the voluminous hide armchairs of the clubs of the last century, Le Club reinterprets one of the archetypes of design with a contemporary approach. No compromise on comfort nor on the quality of execution for an armchair that lightens the shapes and materials in the name of a more casual elegance. Between craftsmanship and technology, Le Club is destined to become timeless, a new icon of domestic spaces and institutional places.







Nelle pagine introduttive: dettagli della poltrona Le Club in pelle non sfoderabile Silk 06 roccia e nella pagina successiva poltrone Le Club, rivestimenti non sfoderabili in tessuto Agadir 09 giada, pelle Silk 06 roccia e 01 crema. Nella pagina precedente: poltrone Le Club in pelle non sfoderabile Silk 06 roccia. Divano Saint-Germain in tessuto sfoderabile Agadir 06 ocra, cuscini in tessuto Nancy 101 carbone, piedini brown nickel opaco. Tavolini Koishi con piani in vetro blu riflettente e struttura verniciato brunito. Composizione sospesa Code retroilluminata in laccato metallico bronzo, vani a giorno in laccato opaco bronzo e schienali in rovere gold. Tappeto Cannelé. A destra: dettaglio della poltrona Le Club in pelle non sfoderabile Silk 01 crema.

Introduction pages: close up of the Le Club armchair in non-removable leather Silk 06 roccia and on the following page Le Club armchairs, non-removable cover in fabric Agadir 09 giada, leather Silk 06 roccia and 01 crema. Previous page: Le Club armchairs in non-removable leather Silk 06 roccia. Saint-Germain sofa in removable fabric Agadir 06 ocra, cushions in fabric Nancy 101 carbone, mat brown nickel feet. Koishi coffee tables with tops in blu reflecting glass and painted brunito structure. Wall mounted backlite Code composition in metal lacquer bronzo, open compartments in mat lacquer bronzo and backs in gold oak. Carpet Cannelé. To the right: close up of the Le Club armchair in non-removable leather Silk 01 crema.





Qui e nella pagina successiva: poltrona Le Club, rivestimento non sfoderabile in pelle Silk 01 crema. Nella successiva: divano Saint-Germain in tessuto sfoderabile Siro 01 bianco, cuscini in tessuto Brest 11 cioccolato e in velluto Persia 2020 bruciato, piedini brown nickel opaco. Tavolini Koishi, piani in marmo zecevo levigato e vetro blu riflettente, struttura champagne opaco. Madia Code in noce gold con top in laccato metallico bronzo, vano a giorno in laccato opaco bronzo e basamento con piedini ardesia opaco. Tappeto Relief cammello.

Here and following page: Le Club armchair, non-removable cover in leather Silk 01 crema. Following page: Saint-Germain sofa in removable fabric Siro 01 bianco, cushions in fabric Brest 11 cioccolato and in velvet Persia 2020 bruciato, mat brown nickel feet. Koishi coffee tables, tops in mat marble zecevo and blu reflecting glass, mat champagne structure. Code sideboard in gold walnut with top in metal lacquer bronzo, open compartment in mat lacquer bronzo and base with feet in mat ardesia. Carpet Relief cammello.



Qui e nella pagina successiva: poltrona Le Club, rivestimento non sfoderabile in tessuto Agadir 09 giada.

Here and next page: Le Club armchair, non-removable cover in fabric Agadir 09 giada.





LE CLUB

Design Jean-Marie Massaud

Struttura in acciaio con seduta sostenuta da cinghie elastiche e giunti di unione tra schienale e seduta in alluminio. Imbottitura in poliuretano flessibile stampato. Appoggio a terra con scivoli in materiale plastico trasparente. Rivestimento non sfoderabile in tessuto o pelle.

Structure in steel with seat supported by elastic belts and aluminium joints between backrest and seat. Padding in flexible moulded polyurethane. Ground support with chutes in transparent plastic material. Non-removable cover in fabric or leather.

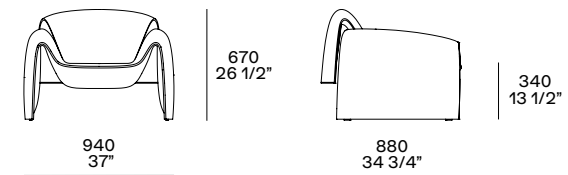

ORBIT

Gioiello di essenzialità, Orbit è un tavolino realizzato interamente in vetro la cui semplicità nasconde una lavorazione laboriosa e complessa. Visivamente leggero e minimale, ha tuttavia un aspetto scultoreo che lo mette in dialogo con qualsiasi ambiente, dal più classico al più contemporaneo.

A gem of minimalism, Orbit is a coffee table made entirely of glass whose simplicity hides a laborious and complex manufacturing process. Visually light and minimal, yet with a sculptural look that connects it with any environment, from the most classic to the most contemporary.

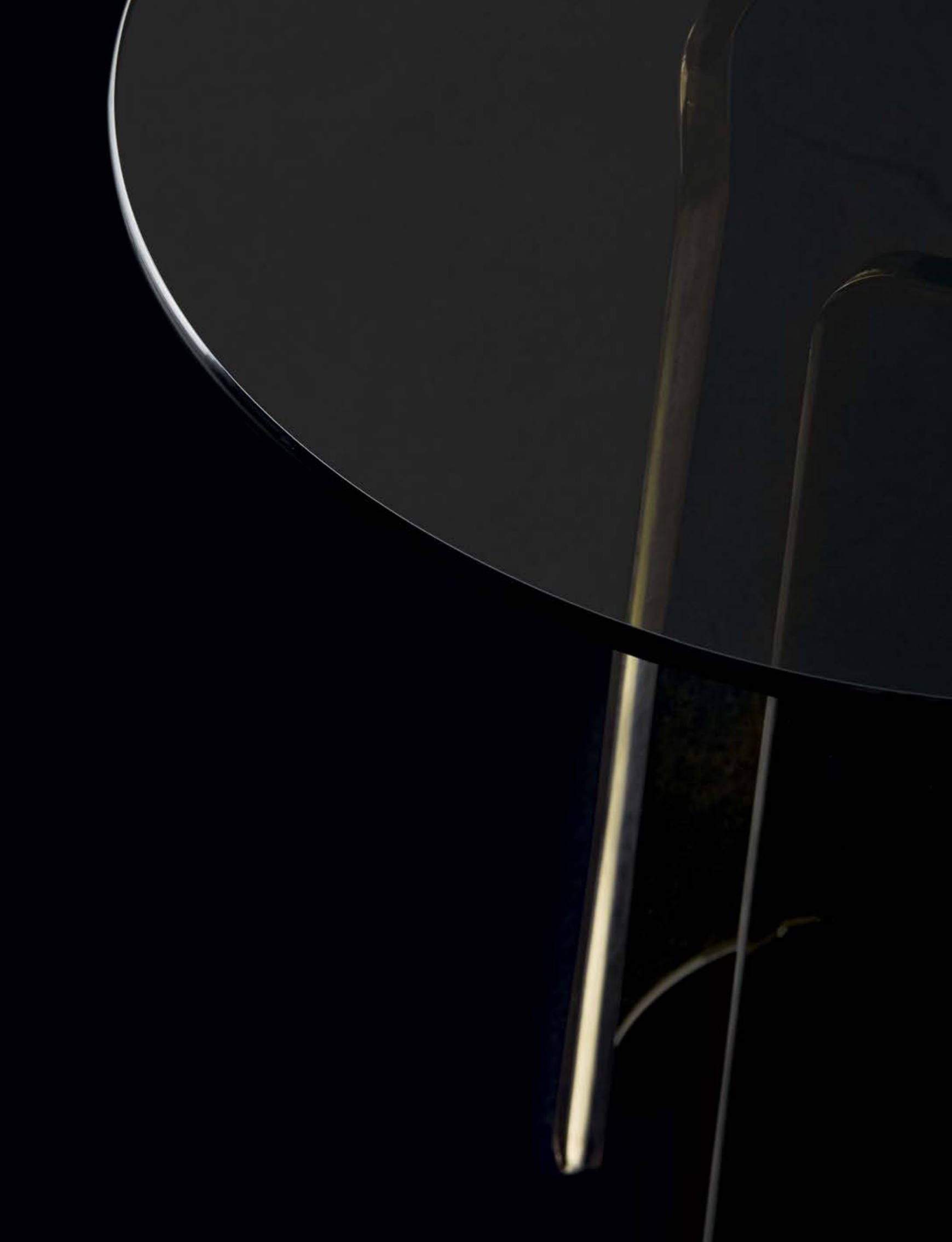



Qui e nella pagina successiva: tavolini Orbit nelle due versioni alto e basso, entrambi con piano e struttura in vetro bronzato, struttura in vetro soffiato. Nella successiva: divano Saint-Germain in tessuto sfoderabile Agadir 06 ocra, cuscini in velluto Persia 1404 carbone e in tessuto Nancy 101 carbone, piedini brown nickel opaco. Tavolini Koishi con piani in vetro blu riflettente e marmo zecevo levigato, struttura verniciato brunito. Tappeto Cannelé.

Here and following page: Orbit coffee tables in the two versions high and low, both with top and structure in bronzed glass, structure in blown glass. Following page: Saint-Germain sofa in removable fabric Agadir 06 ocra, cushions in velvet Persia 1404 carbone and in fabric Nancy 101 carbone, mat brown nickel feet. Koishi coffee tables with tops in blu reflecting glass and mat marble zecevo, structure painted brunito. Carpet Cannelé.



Qui e nella pagina successiva: dettaglio del tavolino Orbit, piano e struttura in vetro bronzato, struttura in vetro soffiato.

This and following page: close up of the Orbit coffee table, top and structure in bronzed glass, structure in blown glass.





ORBIT
Design Jean-Marie Massaud

Piano e struttura in vetro bronzato, struttura
in vetro soffiato.

Top and structure in bronzed glass, structure
in blown glass.

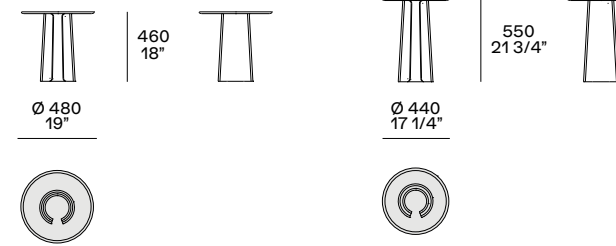

SEATTLE STOOL



La collezione di sedute Seattle, disegnata da Jean-Marie Massaud nel 2015, si completa con lo sgabello, dalle proporzioni ancora più eleganti. Come le sedie, anche lo sgabello si riconosce per la qualità della lavorazione del rivestimento in cuoio, con cuciture e punzonature ispirate alla tradizione calzaturiera britannica.

The Seattle chair collection, designed by Jean-Marie Massaud in 2015, is completed by the stool, with even more elegant proportions. Like the chairs, the stool too is distinguished by the quality of the hide covering manufacturing, with stitching and punching inspired by the British shoemaking tradition.



Nelle pagine introduttive: dettagli dello sgabello Seattle con seduta e gambe rivestite in cuoio non sfoderabile 29 tortora. In questa pagina: sgabelli Seattle, nelle due versioni alta e bassa, entrambi con seduta e gambe rivestite in cuoio non sfoderabile 29 tortora.

Introduction pages: close up of the stool Seattle with seat and legs covered in non-removable hide 29 tortora. This page: Seattle stools in the two versions, high and low, both with seat and legs covered in non-removable hide 29 tortora.





Nella pagina precedente: sgabelli Seattle in cuoio non sfoderabile 29 tortora. Cucina Alea Pro, isola centrale con piano a sbalzo Planar in Inalco MDi® calacatta oro touch, ante in LCT super white e sagoma anodizzato champagne. Colonne e basi a parete in STM acciaio, top in laminato tuttocolore touch super white. Ante vetrina PR24 anodizzato champagne e vetro riflettente fumé, illuminazione a led integrata. Schienali modulari Deep Shaker in anodizzato moka e nobilitato olmo. A destra: dettaglio dello sgabello Seattle in cuoio 29 tortora che evidenzia la lavorazione con broguering. Nella successiva: sgabello Seattle, nella versione alta, seduta e gambe rivestite in cuoio non sfoderabile 29 tortora.

Previous page: Seattle stools in non-removable hide 29 tortora. Kitchen Alea Pro, central island with cantilevered worktop Planar in Inalco MDi® calacatta oro touch, doors in LCT super white and anodized champagne groove. Tall units and base units to the wall in STM steel, worktop in laminate tuttocolore touch super white. Glass doors PR24 anodized champagne and fumé reflecting glass, integrated led lighting. Deep Shaker modular backs in anodized moka and elm melamine. To the right: close up of the stool Seattle in hide 29 tortora which highlights the broguering manufacturing. Following page: Seattle stool, in the high version, seat and legs covered in non-removable hide 29 tortora.





SEATTLE STOOL

Design Jean-Marie Massaud

Seduta in poliuretano integrale con inserto in metallo. Seduta, schienale e gambe completamente rivestite in cuoio non sfoderabile nei colori 19 caffè, 02 nero, 26 invecchiato o 29 tortora con punzonatura estetica (broguering) perimetrale. Poggiapiedi in metallo verniciato.

Seat in integral polyurethane with metal insert. Seat and backrest fully covered in non-removable hide in the colours 19 caffè, 02 nero, 26 invecchiato or 29 tortora with perimeter decorative punching (broguing). Footrest in painted metal.

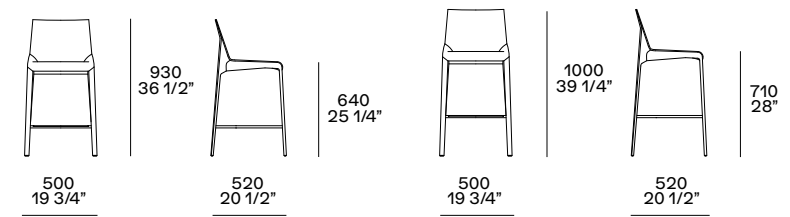

GENTLEMAN NIGHT COLLECTION

La collezione Gentleman, disegnata da Marcel Wanders, si amplia dal living alla zona notte. Come il nucleo originario, composto di poltrone, pouf e divano, anche la nuova estensione si riconosce per lo stile classico ed esclusivo e la cura nei dettagli, perfetto mix di comfort e raffinatezza. Il letto richiama l'alto poggiatesta di Gentleman Reserved nel disegno alto e curvo della testiera. Riferimenti classici per comodino e cassettera, con top in laccato opaco colori.

The Gentleman collection, designed by Marcel Wanders, expands from the living room to the night area. Like the original core, made up of armchairs, pouf, and sofa, the new extension too is distinguished by its classic and exclusive style and attention to detail, a perfect mix of comfort and refinement. The bed resembles the high headrest of Gentleman Reserved with the tall and curved design of the headboard. Classic references for night table and chest of drawers, with top in mat lacquered colours.

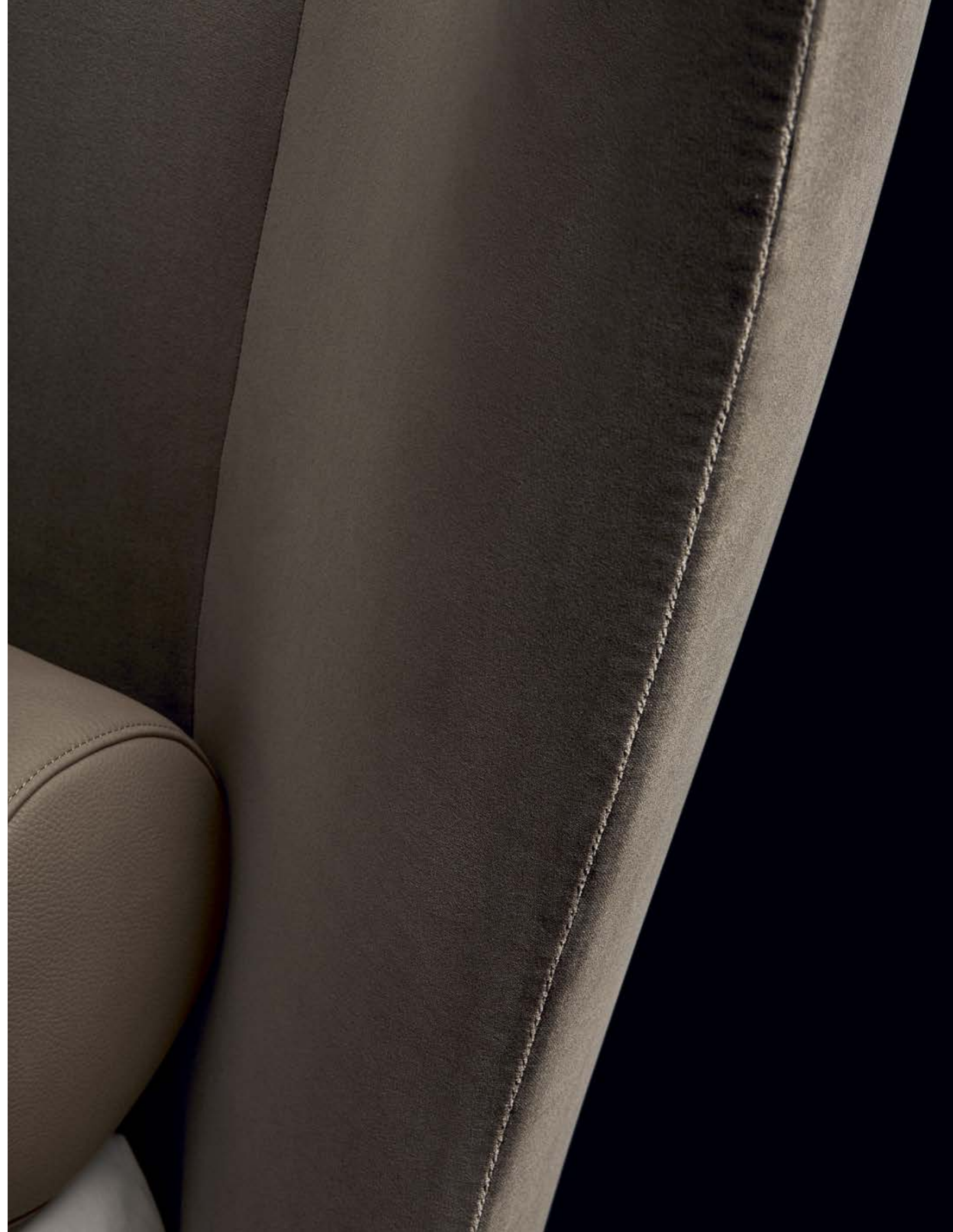





Qui e nelle pagine precedenti: letto Gentleman, testata e base imbottite in velluto Persia sfoderabile 2012 visone, basamento brown nickel lucido. Rulli in pelle Silk 02 beige. Biancheria da letto coordinata in cotone Provence 01 bianco e 03 ghiaccio con profilo nero. Coperta Linus notte. Cassettiera e comodini Gentleman in olmo nero con top in laccato opaco bronzo e piedini brown nickel lucido. Mensolone retroilluminato Code in olmo nero e pouf New York in tessuto sfoderabile Sparta 04 sabbia. Poltrona Gentleman Single in tessuto sfoderabile Arcadia 05 bronzo, piedini brown nickel lucido. Pouf Play in pelle non sfoderabile Silk 12 senape. Tavolino Mondrian in marmo zecevo levigato e brown nickel lucido. Tappeto Plain natural.

This and previous pages: Gentleman bed, padded headboard and base in removable velvet Persia 2012 visone, glossy brown nickel base. Roll cushions in leather Silk 02 beige. Coordinated bed set in cotton Provence 01 bianco and 03 ghiaccio with profile nero. Linus blanket notte. Gentleman chest of drawers and night tables in black elm with top in mat lacquer bronzo and glossy brown nickel feet. Backlit thick shelf Code in black elm and New York pouf in removable fabric Sparta 04 sabbia. Gentleman Single armchair in removable fabric arcadia 05 bronzo, glossy brown nickel feet. Play pouf in non-removable leather Silk 12 senape. Mondrian coffee table in mat marble zecevo and glossy brown nickel feet. Carpet Plain natural.





A sinistra: dettaglio del comodino Gentleman con cassetto in olmo nero e interno in nobilitato ardesia, top in laccato opaco bronzo. Nella pagina successiva: comodino e cassetiera Gentleman in olmo nero con top in laccato opaco bronzo, piedini brown nickel lucido.

To the left: close up of the Gentleman night table with drawer in black elm and melamine ardesia interior, top in mat lacquer bronzo. Next page: night table and chest of drawers Gentleman in black elm with top in mat lacquer bronzo, glossy brown nickel feet.



In questa pagina: comodino Gentleman in noce gold con top in laccato opaco champagne, il dettaglio evidenzia la lavorazione del top.

This page: Gentleman night table in gold walnut with top in mat lacquer champagne, the detail highlights the manufacturing of the top.

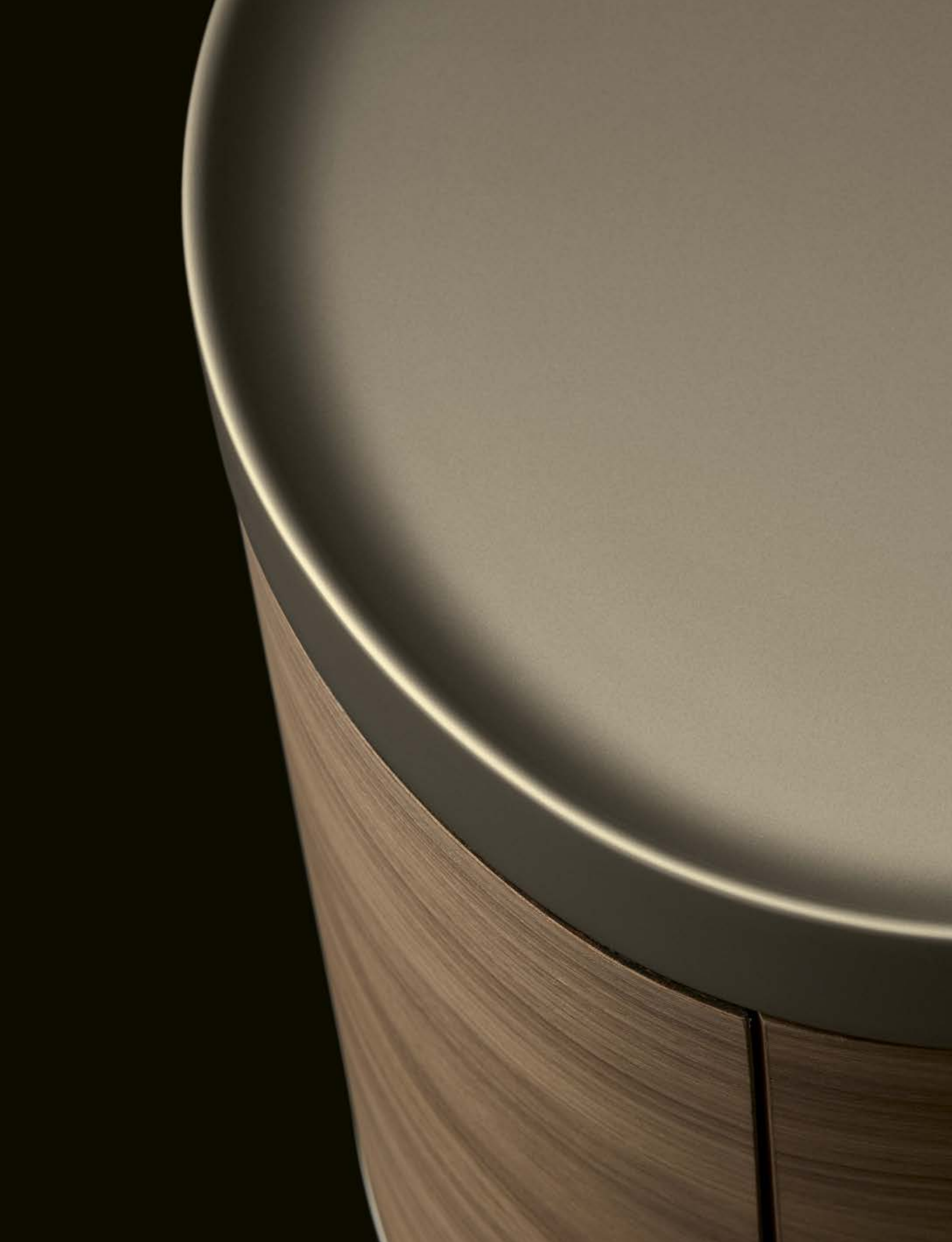



In questa pagina: comodino Gentleman in noce gold con top in laccato opaco champagne e piedini champagne opaco.

This page: Gentleman coffee table in gold walnut with top in mat lacquer champagne and mat champagne feet.

GENTLEMAN

Design Marcel Wanders

Letto con testata imbottita in poliuretano stampato con telaio metallico, prriverestimento in ovatta di poliestere.

Base imbottita, fusto in legno e derivati, ricoperto con poliuretano espanso a quote differenziate, prriverestimento in ovatta di poliestere.

Rivestimento sfoderabile in tessuto o pelle. Bordura gros-grain nei colori da campionario. Basamento in metallo verniciato champagne opaco, brown nickel opaco o lucido.

Coppia rulli opzionale con rivestimento sfoderabile in tessuto o pelle.

Predisposto per materassi

l 1600-1800 x p 2000

Tipologia di rete

rete fissa a doghe flessibili

Bed with padded headboard in moulded polyurethane foam with metal frame, pre-covering in polyester wadding.

Padded base, structure in wood and wood by-products, covered with multi-density polyurethane foam, pre-cover in polyester wadding.

Removable covering fabric or leather. Grosgrain border in the sample colours.

Base in metal mat painted champagne, mat or glossy brown nickel.

Optional pair of roll cushions with removable fabric or leather covering.

For mattresses

w 63"-70 3/4" x d 78 3/4"

Bedstead type

fixed with flexible slats

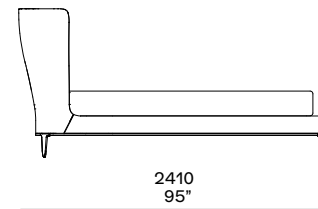
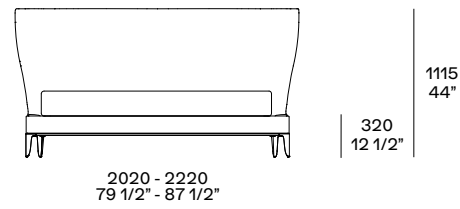

Comodino e cassettiera con struttura e frontali in olmo nero o noce gold. Top in laccato opaco colori. Piedini in metallo verniciato champagne opaco o brown nickel opaco e lucido.

Night table and chest of drawers with structure and fronts in black elm or gold walnut. Top in mat lacquer colours. Feet in metal mat painted champagne or in mat and glossy brown nickel.

Comodino Night table

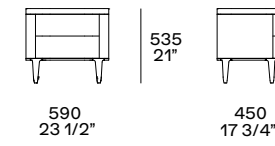

Cassettiera Chest of drawers

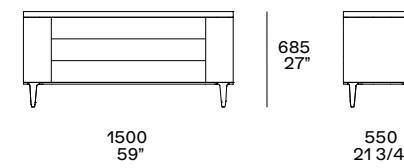



RELIEF - CANNELÉ

La collezione di tappeti si arricchisce di due nuovi design. Disponibile nei colori perla, cammello e tortora, il tappeto Relief unisce all'effetto cannettato un decoro perimetrale, ottenuto tagliando il vello ad altezze diverse. Cannelé è invece un tappeto bicolore caratterizzato dal motivo rigato. A definire più precisamente le righe è la giustapposizione di due lavorazioni – bouclé per il nero, vello tagliato a mano per il perla. Entrambi i tappeti sono realizzati in un blend di lana himalayana e seta di bambù, che li rende morbidi e piacevoli al tatto.

The carpet collection is enriched by two new designs. Available in perla, cammello, and tortora colours, the Relief carpet combines the ribbed effect with a perimeter decoration, obtained by cutting the fleece at different heights. Cannelé is instead a two-coloured carpet characterized by a striped pattern. What further defines the difference of the stripes is the juxtaposition of two techniques – bouclé for the nero, hand-cut fleece for the perla. Both carpets are made of a blend of Himalayan wool and bamboo silk, which makes them soft and pleasant to the touch.





RELIEF

Design R&D Poliform

Prodotto a mano con tecnica handloom.
Trama in cotone, vello in lana himalayana
e seta di bambù, bouclé in lana himalayana.
Dimensioni mm: rettangolare 1700×2400
2300×3000 - 3000×4000
quadrato 3000×3000.

Handmade with the handloom technique.
Cotton weave, fleece in Hymalayan wool
and bamboo silk, Hymalayan wool bouclé.
Dimensions in: rectangular 67"×94 1/2"
90 1/2"×118" - 118"×157 1/2"
square 118"×118".



Perla



Cammello

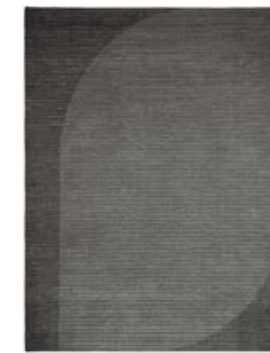

Tortora



CANNELÉ

Design R&D Poliform

Prodotto a mano con tecnica handloom.
Trama in cotone, vello in lana himalayana
e seta di bambù, bouclé in lana himalayana.
Dimensioni mm: rettangolare 1700×2400
2300×3000 - 3000×4000
quadrato 3000×3000.

Handmade with the handloom technique.
Cotton weave, fleece in Hymalayan wool
and bamboo silk, Hymalayan wool bouclé.
Dimensions in: rectangular 67"x94 1/2"
90 1/2"x118" - 118"x157 1/2"
square 118"x118".



LINUS

La coperta Linus è in pura lana lavorata a nido d'ape, un motivo che le conferisce un aspetto materico e contemporaneo. Leggera ma calda, in versione copriletto o plaid, si abbina ai tessuti e alle pelli della collezione con una palette colori che comprende cinque varianti – latte, sabbia, granata, notte e grafite.

The Linus blanket is made of pure honeycomb wool, a pattern that gives it a material and contemporary look. Light but warm, in the version bedcover or blanket, it is designed to match the fabrics and leathers of the collection and includes five colour variants – latte, sabbia, granata, notte, and grafite.

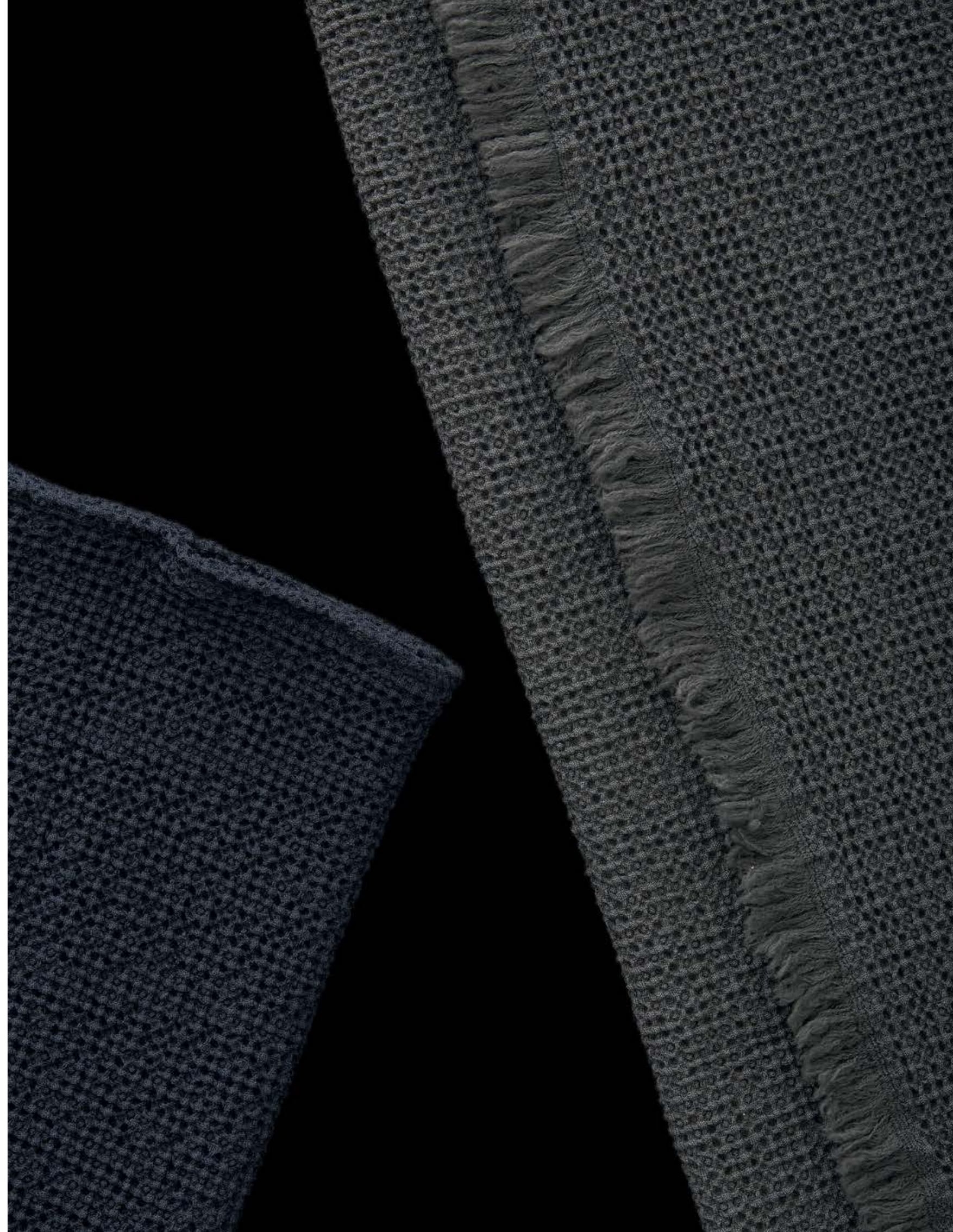



LINUS

Design R&D Poliform

Coperta in pura lana con lavorazione a nido d'ape. Disponibile nelle due versioni plaid e copriletto.

Dimensioni mm: plaid 1100×2400
copriletto 2200×2400

Pure wool blanket with honeycomb pattern. Available in two versions, plaid and bedcover.

Dimensions in: plaid 43 1/4"×94 1/2"
bedcover 86 1/2"×94 1/2"



Latte



Sabbia



Grafite



Notte



Granata

La versatilità del sistema Saint-Germain si traduce in una grande libertà progettuale. Combinati tra loro, gli elementi danno vita a diverse composizioni – dal divano lineare alle classiche configurazioni a L. Con gli elementi freestanding, caratterizzati da linee curve, si creano invece composizioni organiche, di qualsiasi dimensione.

The versatility of the Saint-Germain system translates into great design freedom. Combined with one another, the elements give life to different compositions – from the linear sofa to the classic L-shaped configurations. With the freestanding elements, characterized by curved lines, you can instead create organic compositions of any size.

| | | |
|--------------------|----------------|-----|
| SAINT-GERMAIN SOFA | COMPOSITION 01 | 140 |
| | COMPOSITION 02 | 144 |
| | COMPOSITION 03 | 148 |
| | COMPOSITION 04 | 152 |
| | COMPOSITION 05 | 156 |
| | COMPOSITION 06 | 160 |
| | COMPOSITION 07 | 164 |
| | COMPOSITION 08 | 168 |



COMPOSITION 01

1 Saint-Germain divano

Rivestimento divano e cuscini schienale in tessuto sfoderabile Naxos 17 corda. Cuscini opzionali in tessuto sfoderabile Naxos 17 corda, Brest 05 danubio e velluto sfoderabile Persia 58 danubio.

2 Saint-Germain pouf

Rivestimento sfoderabile in pelle Deep 05 cioccolato.

3 Koishi tavolini

Strutture verniciato brunito. Piano in marmo calacatta oro levigato. 1200x1090 h 270
Piano in olmo nero. 500x500 h 530

4 Le Club poltrona

Rivestimento non sfoderabile in tessuto Brest 12 sabbia. 1940 p 880 h 670

5 Orbit tavolini

Piano e struttura in vetro bronzato, struttura in vetro soffiato. Ø 440 h 550 - Ø 480 h 460

6 Cannelé tappeto

Dimensioni su misura 3400x5300

1 Saint-Germain sofa

Sofa and backrest cushions cover in removable fabric Naxos 17 corda. Optional cushions in removable fabric Naxos 17 corda, Brest 05 danubio and removable velvet Persia 58 danubio.

2 Saint-Germain pouf

Removable cover in leather Deep 05 cioccolato.

3 Koishi coffee tables

Structures painted brunito. Top in mat marble calacatta oro. 47 1/4"x43" h 10 3/4"
Top in black elm. 19 3/4"x19 3/4" h 20 3/4"

4 Le Club armchair

Non-removable cover in fabric Brest 12 sabbia. w 37" d 34 3/4" h 26 1/2"

5 Orbit coffee tables

Top and structure in bronzed glass, structure in blown glass. Ø 17 1/4" h 21 3/4" - Ø 19" h 18"

6 Cannelé carpet

Customized sizes 133 3/4"x208 3/4"

Saint-Germain divano
Saint-Germain sofa

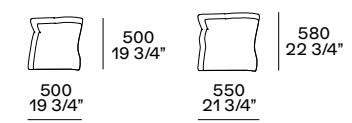
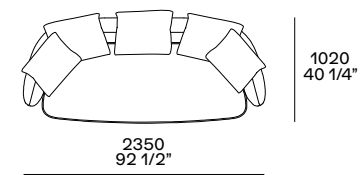

Cuscini opzionali
Optional cushions

Saint-Germain pouf
Saint-Germain pouf

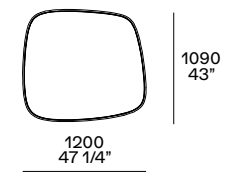

Koishi tavolini
Koishi coffee tables

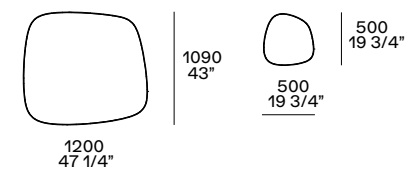

Le Club poltrona
Le Club armchair

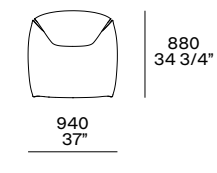

Orbit tavolini
Orbit coffee tables

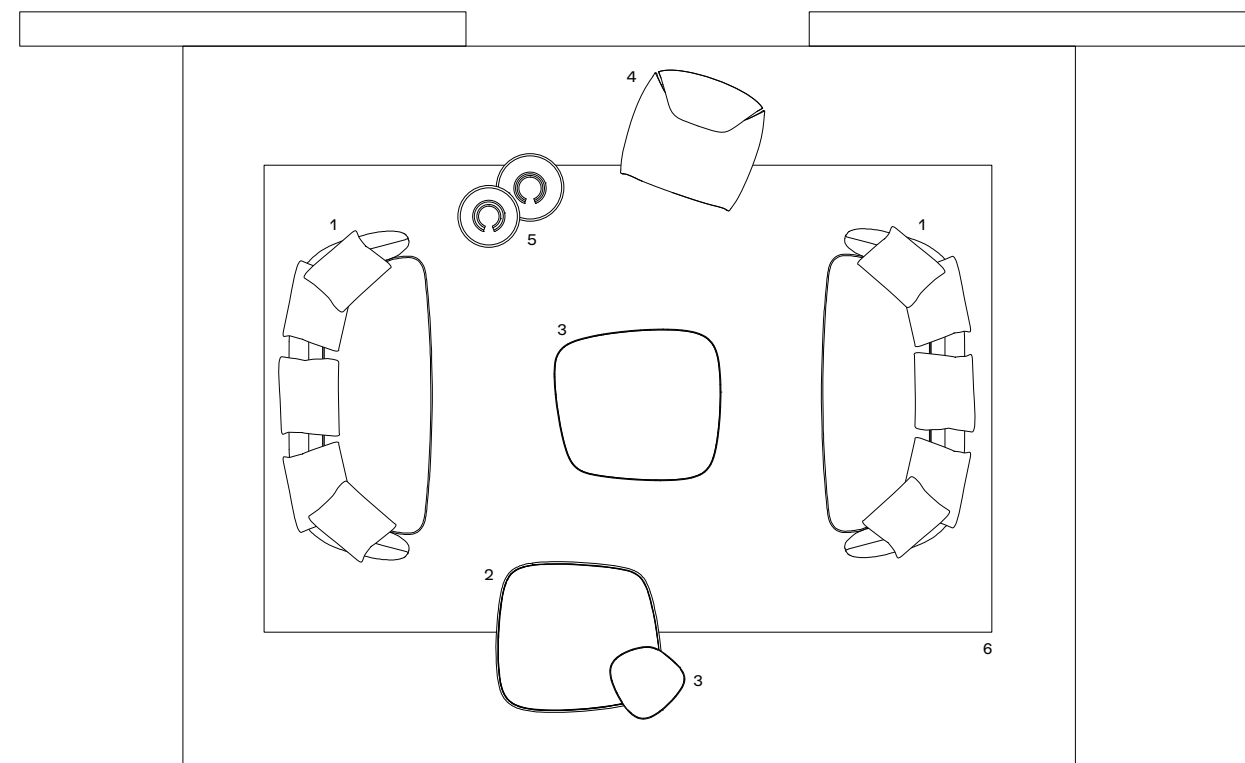
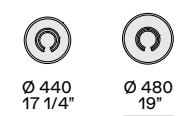

Display 34 mq-sqm



naxos 17 corda
tessuto - fabric



brest 05 danubio
tessuto - fabric



persia 58 danubio
velluto - velvet

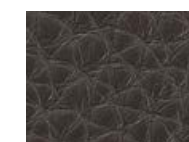

deep 05 cioccolato
pelle - leather



brest 12 sabbia
tessuto - fabric



calacatta oro
marmo levigato
mat marble

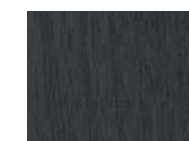

olmo nero
black elm

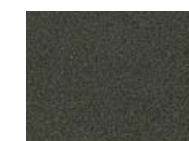

verniciato brunito
painted brunito



3051 bronzato
vetro - glass



COMPOSITION 02

1 Saint-Germain divano

Rivestimento divano e cuscini schienale in tessuto sfoderabile Arcadia 02 sabbia. Cuscini opzionali in velluto sfoderabile Tebe 06 giada.

l 3200 p 1540

2 Koishi tavolini

Strutture verniciato champagne opaco. Piano in marmo zecevo levigato. 1200x1090 h 270

Piano in vetro blu riflettente. 500x500 h 530

3 Kay Lounge poltrona

Rivestimento non sfoderabile in cuoio 02 nero e struttura in cromo satinato. l 730 p 735 h 675

4 Orbit tavolini

Piano e struttura in vetro bronzato, struttura in vetro soffiato. Ø 440 h 550 - Ø 480 h 460

5 Relief tappeto

Colore tortora. Dimensioni su misura 3000x5000

1 Saint-Germain sofa

Cover of sofa and backrest cushions in removable fabric Arcadia 02 sabbia. Optional cushions in removable velvet Tebe 06 giada.

w 126"d 60 3/4"

2 Koishi coffee tables

Structures painted mat champagne. Top in mat marble zecevo. 47 1/4"x43" h 10 3/4"

Top in blu reflecting glass. 19 3/4"x19 3/4" h 20 3/4"

3 Kay Lounge armchair

Non-removable cover in hide 02 nero and satin chrome structure. w 28 3/4" d 29" h 26 1/2"

4 Orbit coffee tables

Top and structure in bronzed glass, structure in blown glass. Ø 17 1/4" h 21 3/4" - Ø 19" h 18"

5 Relief carpet

Colour tortora. Customized sizes 118"x196 3/4"

Saint-Germain divano Saint-Germain sofa

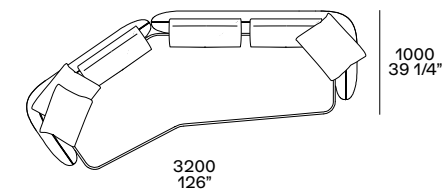

Divano Boomerang sx
Lt Boomerang sofa

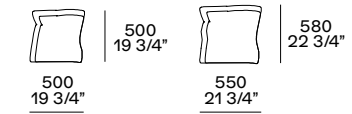

Cuscini opzionali
Optional cushions

Koishi tavolini Koishi coffee tables

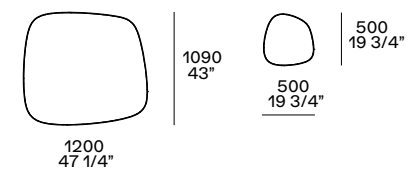

Kay Lounge poltrona Kay Lounge armchair

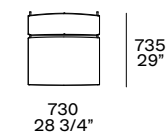

Orbit tavolini Orbit coffee tables

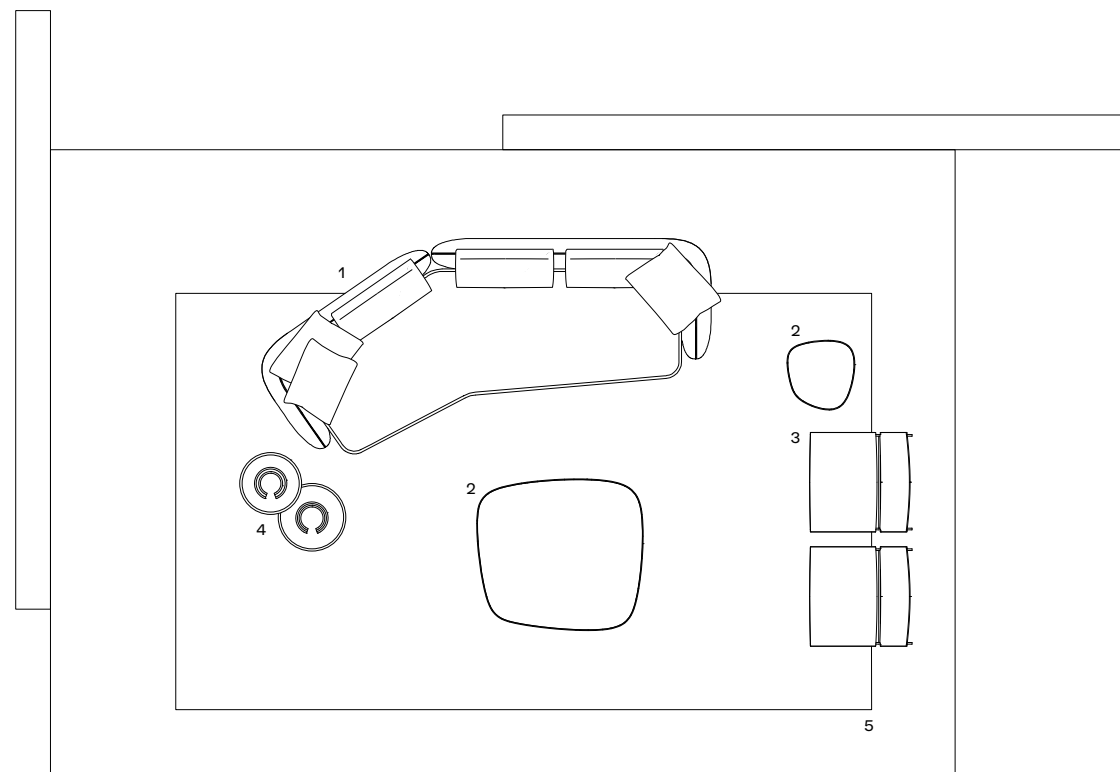
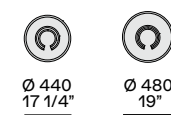

Display 30 mq-sqm

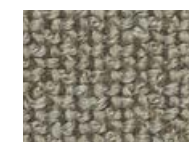

arcadia 02 sabbia
tessuto - fabric

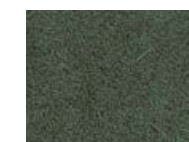

tebe 06 giada
velluto - velvet

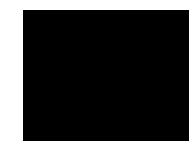

02 nero
cuoio - hide



cromo satinato
brushed chrome



zecevo
marmo levigato
mat marble



5010 blu
vetro riflettente
reflecting glass



champagne opaco
mat champagne



3051 bronzato
vetro - glass



COMPOSITION 03

1 Saint-Germain divano

Rivestimento divano e cuscini schienale in tessuto sfoderabile Brest 04 pepe. Cuscini opzionali in tessuto sfoderabile Brest 04 pepe e pelle sfoderabile Silk 08 nero. Composizione l 3180 p 1810

1 Saint-Germain sofa

Sofa and backrest cushions cover in removable fabric Brest 04 pepe. Optional cushions in removable fabric Brest 04 pepe and removable leather Silk 08 nero. Composition w 125 1/4" d 71 1/4"

2 Koishi tavolini

Strutture verniciato champagne opaco. Piano in pietra ebano spatolata. 1200x1090 h 270
Piano in vetro blu riflettente. 500x500 h 530

2 Koishi coffee tables

Structures mat painted champagne. Top in spatula-finish ebony stone. 47 1/4"x43" h 10 3/4"
Top in blu reflecting glass. 19 3/4"x19 3/4" h 20 3/4"

3 Kay Lounge poltrona

Rivestimento non sfoderabile in pelle Hairy cappuccino e struttura verniciato brown nickel opaco. l 730 p 735 h 675

3 Kay Lounge armchair

Non-removable cover in leather Hairy cappuccino and structure painted mat brown nickel. w 28 3/4" d 29" h 26 1/2"

4 Orbit tavolini

Piano e struttura in vetro bronzato, struttura in vetro soffiato. Ø 440 h 550 - Ø 480 h 460

4 Orbit coffee tables

Top and structure in bronzed glass, structure in blown glass. Ø 17 1/4" h 21 3/4" - Ø 19" h 18"

5 Plain tappeto

Colore tortora. Dimensioni su misura 4000x5300

5 Plain carpet

Colour tortora. Customized sizes 157 1/2"x208 3/4"

Saint-Germain divano
Saint-Germain sofa

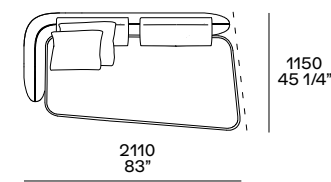

Terminale inclinato sx
Lt angled end unit

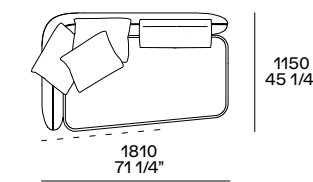

Angolo inclinato sx
Lt angled corner unit

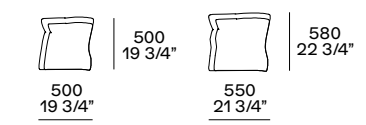

Cuscini opzionali
Optional cushions

Koishi tavolini
Koishi coffee tables

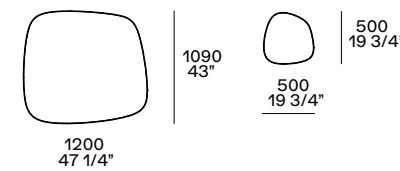

Kay Lounge poltrona
Kay Lounge armchair

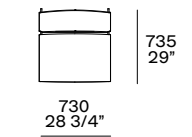

Orbit tavolini
Orbit coffee tables

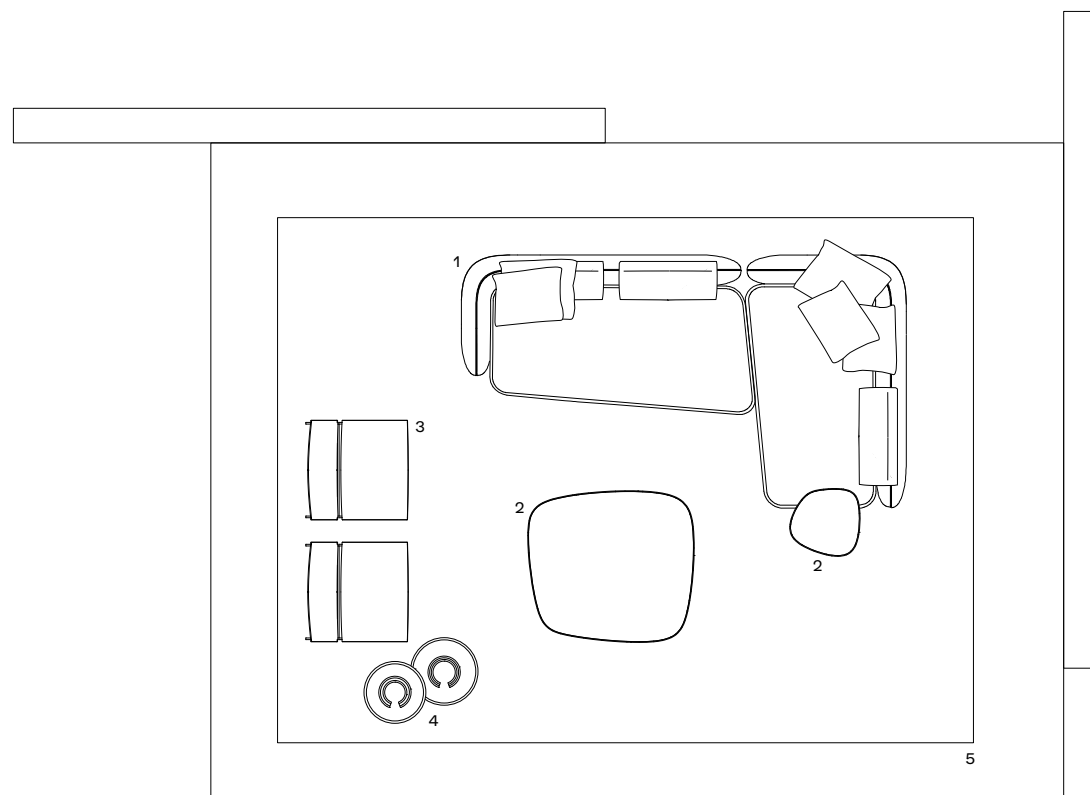
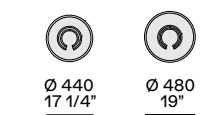

Display 32 mq-sqm



brest 04 pepe
tessuto - fabric

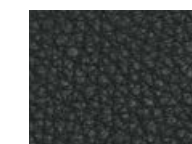

silk 08 nero
pelle - leather



cappuccino
pelle hairy
hairy leather

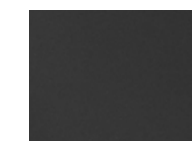

brown nickel opaco
mat brown nickel

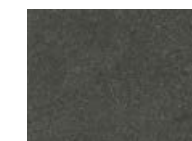

pietra ebano spatolata
spatula-finish ebony
stone



5010 blu
vetro riflettente
reflecting glass

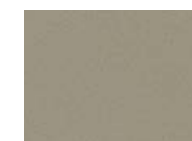

champagne opaco
mat champagne



3051 bronzato
vetro - glass



COMPOSITION 04

1 Saint-Germain divano

Rivestimento divano e cuscini schienale in pelle sfoderabile Silk 10 terracotta. Cuscini opzionali in velluto sfoderabile Glasgow 03 carbone e pelle sfoderabile Silk 10 terracotta. Composizione l 3780 p 1410

1 Saint-Germain sofa

Sofa and backrest cushions cover in removable leather Silk 10 terracotta. Optional cushions in removable velvet Glasgow 03 carbone and removable leather Silk 10 terracotta. Composition w 148 3/4" d 55 1/2"

2 Koishi tavolini

Strutture verniciato brunito. Piano in marmo zecevo levigato. 1200x1090 h 270
Piano in olmo nero. 1050x620 h 270
Piano in vetro blu riflettente. 500x500 h 530

2 Koishi coffee tables

Structures painted brunito. Top in mat marble zecevo. 47 1/4"x43" h 10 3/4"
Top in black elm. 41 1/4"x24 1/2" h 10 3/4"
Top in blu reflecting glass. 19 3/4"x19 3/4" h 20 3/4"

3 Kay Lounge poltrona

Rivestimento non sfoderabile in pelle Hairy bianco/nero e struttura in cromo satinato. l 730 p 735 h 675

3 Kay Lounge armchair

Non-removable cover in leather Hairy bianco/nero and structure in satin chrome. w 28 3/4" d 29" h 26 1/2"

4 Orbit tavolini

Piano e struttura in vetro bronzato, struttura in vetro soffiato. Ø 440 h 550 - Ø 480 h 460

4 Orbit coffee tables

Top and structure in bronzed glass, structure in blown glass. Ø 17 1/4" h 21 3/4" - Ø 19" h 18"

5 Relief tappeto

Colore perla. Dimensioni su misura 3900x5300

5 Relief carpet

Colour perla. Customized sizes 153 1/2"x208 3/4"

Saint-Germain divano Saint-Germain sofa

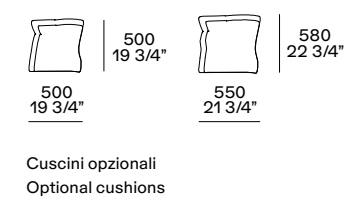
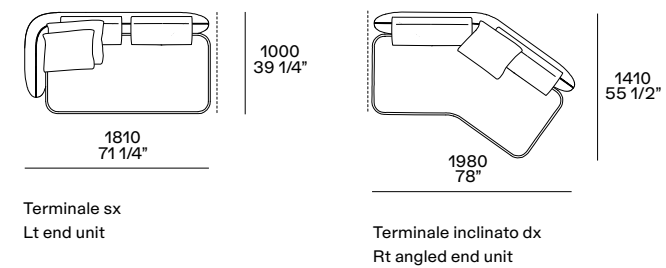

Koishi tavolini Koishi coffee tables

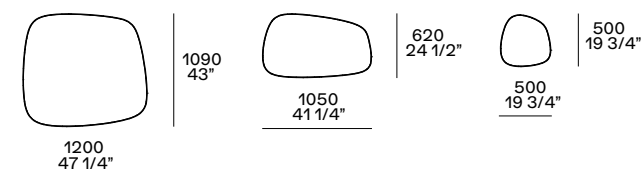

Kay Lounge poltrona Kay Lounge armchair

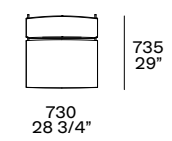

Orbit tavolini Orbit coffee tables

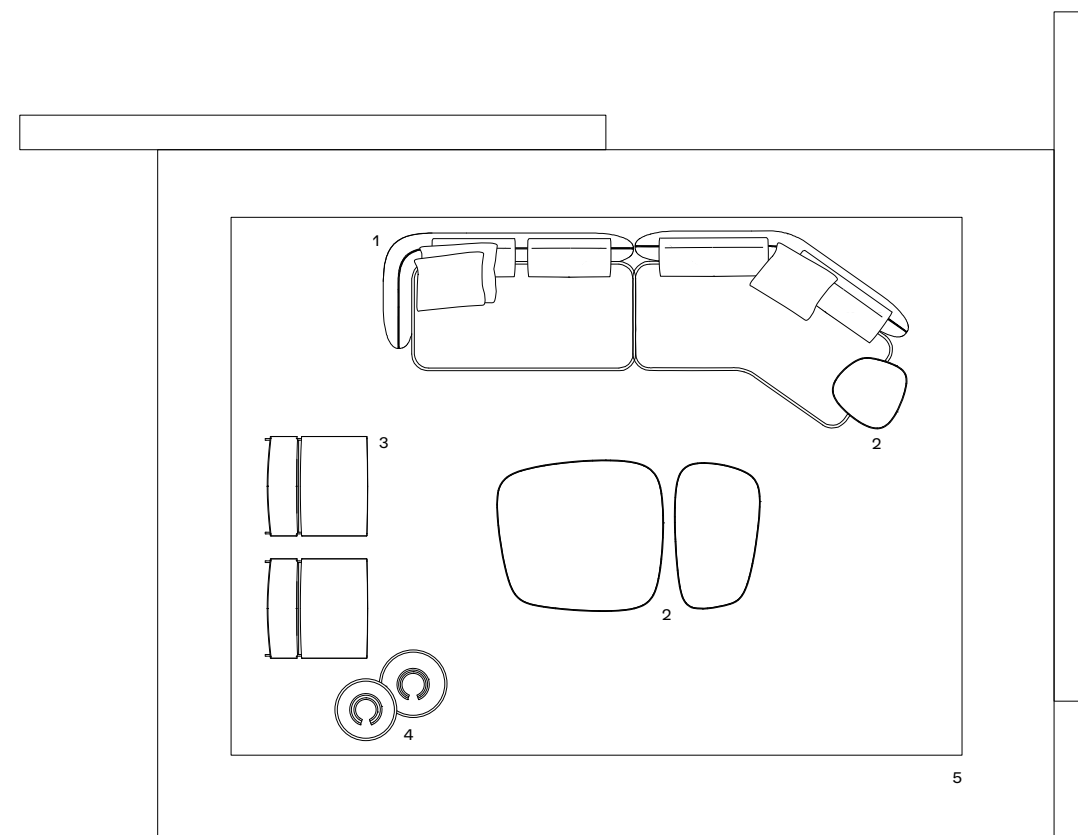
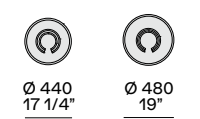

Display 32 mq-sqm



silk 10 terracotta
pelle - leather

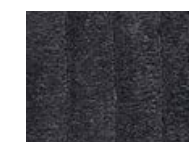

glasgow 03 carbone
velluto - velvet



bianco/nero
pelle hairy
hairy leather



cromo satinato
brushed chrome



zecevo
marmo levigato
mat marble



olmo nero
black elm

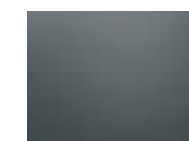

5010 blu
vetro riflettente
reflecting glass

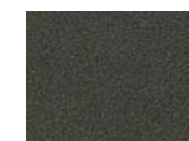

verniciato brunito
painted brunito



3051 bronzato
vetro - glass



COMPOSITION 05

1 Saint-Germain divano

Rivestimento divano e cuscini schienale in tessuto sfoderabile Lima 67 pernice. Cuscini opzionali in velluto sfoderabile Glasgow 03 carbone e tessuto sfoderabile Lima 67 pernice. Composizione l 3680 p 1990

1 Saint-Germain sofa

Sofa and backrest cushions cover in removable fabric Lima 67 pernice. Optional cushions in removable velvet Glasgow 03 carbone and removable fabric Lima 67 pernice. Composition w 145" d 78 1/4"

2 Koishi tavolini

Strutture verniciato brunito. Piano in olmo nero. 1200x1090 h 270
Piano in marmo sahara noir levigato finitura poliestere. 500x500 h 530
890x450 h 360

2 Koishi coffee tables

Structures painted brunito. Top in black elm. 47 1/4"x43" h 10 3/4"
Top in mat marble sahara noir with polyester finish. 19 3/4"x19 3/4" h 20 3/4"
35"x17 3/4" h 14 1/4"

3 Le Club poltrona

Rivestimento non sfoderabile in pelle Silk 12 senape. l 940 p 880 h 670

3 Le Club armchair

Non-removable cover in leather Silk 12 senape. w 37" d 34 3/4" h 26 1/2"

4 Plain tappeto

Colore natural. Dimensioni su misura 4100x4800

4 Plain carpet

Colour natural. Customized sizes 161 1/2"x189"

Saint-Germain divano
Saint-Germain sofa

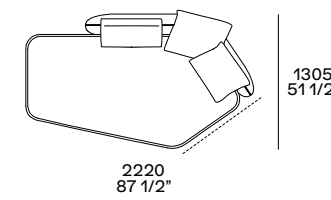

Angolo penisola inclinato dx
Rt angled peninsula end unit

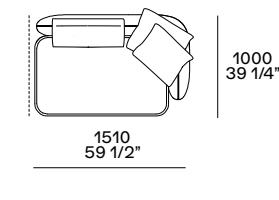

Terminale dx
Rt end unit

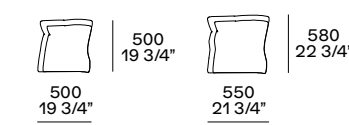

Cuscini opzionali
Optional cushions

Koishi tavolini
Koishi coffee tables

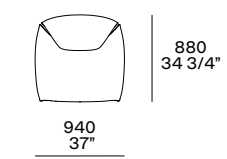
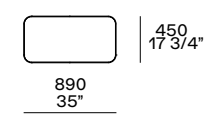
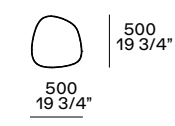
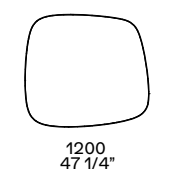

Le Club poltrona
Le Club armchair

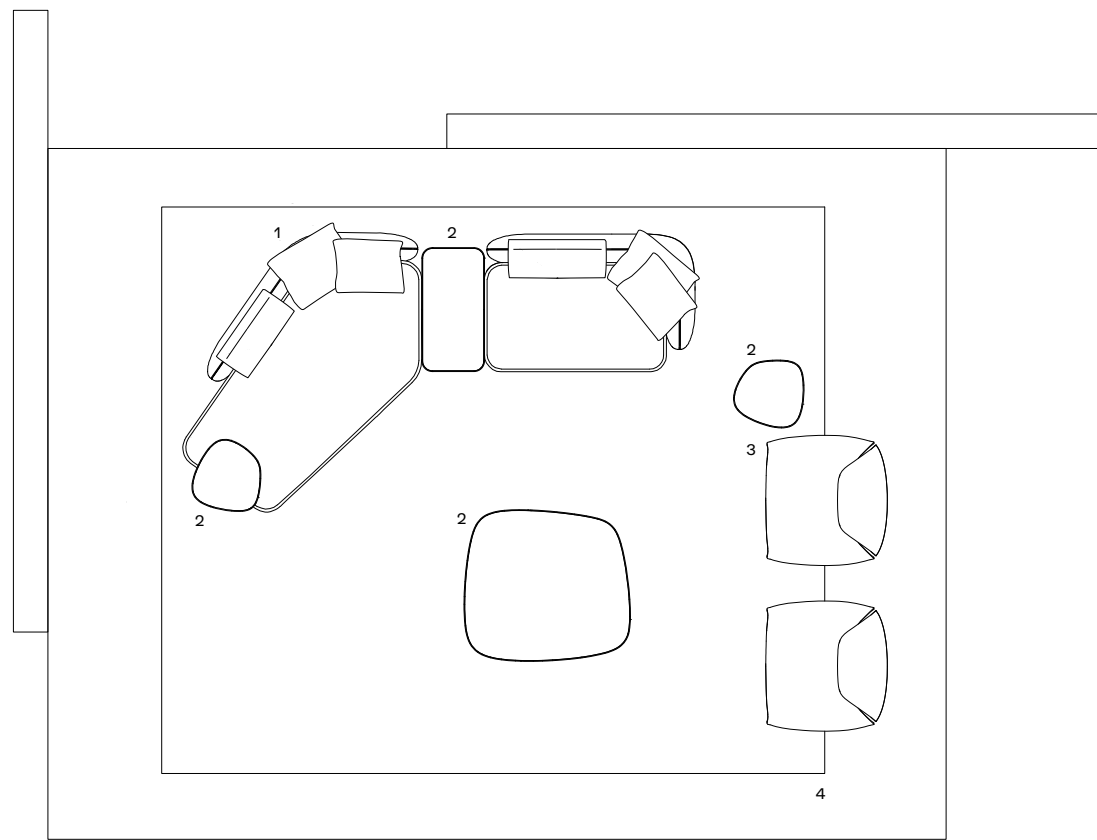

Display 32 mq-sqm



lima 67 pernice
tessuto - fabric

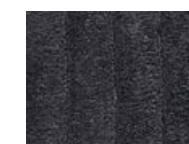

glasgow 03 carbone
velluto - velvet



silk 12 senape
pelle - leather



olmo nero
black elm

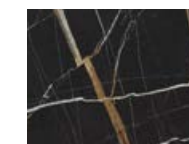

sahara noir
marmo levigato
mat marble

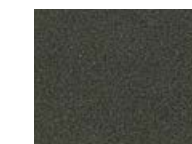

verniciato brunito
painted brunito



COMPOSITION 06

1 Saint-Germain divano

Rivestimento divano e cuscini schienale in tessuto sfoderabile Siro 01 bianco. Cuscini opzionali in tessuto sfoderabile Brest 11 cioccolato e velluto sfoderabile Persia 2002 bruciato. Composizione l 3610 p 3180

1 Saint-Germain sofa

Sofa and backrest cushions cover in removable fabric Siro 01 bianco. Optional cushions in removable fabric Brest 11 cioccolato and removable velvet Persia 2002 bruciato. Composition w 142 1/4" d 125 1/4"

2 Koishi tavolini

Strutture verniciato brunito. Piano in marmo zecevo levigato. 1200x1090 h 270
Piano in olmo nero. 1050x620 h 270
Piano in vetro blu riflettente. 500x500 h 530

2 Koishi coffee tables

Structures painted brunito. Top in mat marble zecevo. 47 1/4"x43" h 10 3/4"
Top in black elm. 41 1/4"x24 1/2" h 10 3/4"
Top in blu reflecting glass. 19 3/4"x19 3/4" h 20 3/4"

3 Le Club poltrona

Rivestimento non sfoderabile in pelle Silk 10 terracotta. l 940 p 880 h 670

3 Le Club armchair

Non-removable cover in leather Silk 10 terracotta. w 37" d 34 3/4" h 26 1/2"

4 Orbit tavolini

Piano e struttura in vetro bronzato, struttura in vetro soffiato. Ø 440 h 550 - Ø 480 h 460

4 Orbit coffee tables

Top and structure in bronzed glass, structure in blown glass. Ø 17 1/4" h 21 3/4" - Ø 19" h 18"

5 Relief tappeto

Colore cammello. Dimensioni su misura 3300x4800

5 Relief carpet

Colour cammello. Customized sizes 130"x189"

**Saint-Germain divano
Saint-Germain sofa**

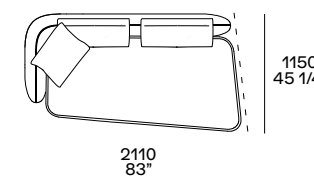

Terminale inclinato sx
Lt angled end unit

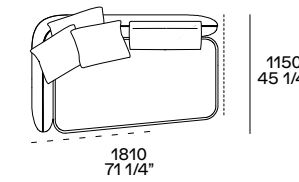

Angolo inclinato sx
Lt angled corner unit

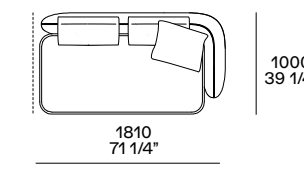

Terminale dx
Rt end unit

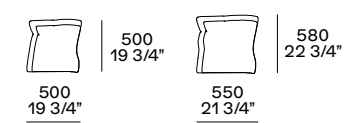

Cuscini opzionali
Optional cushions

**Koishi tavolini
Koishi coffee tables**

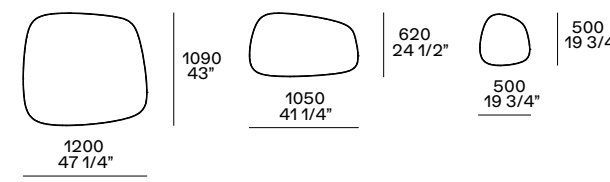

**Le Club poltrona
Le Club armchair**

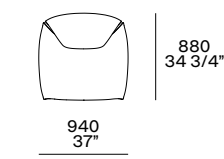

**Orbit tavolini
Orbit coffee tables**

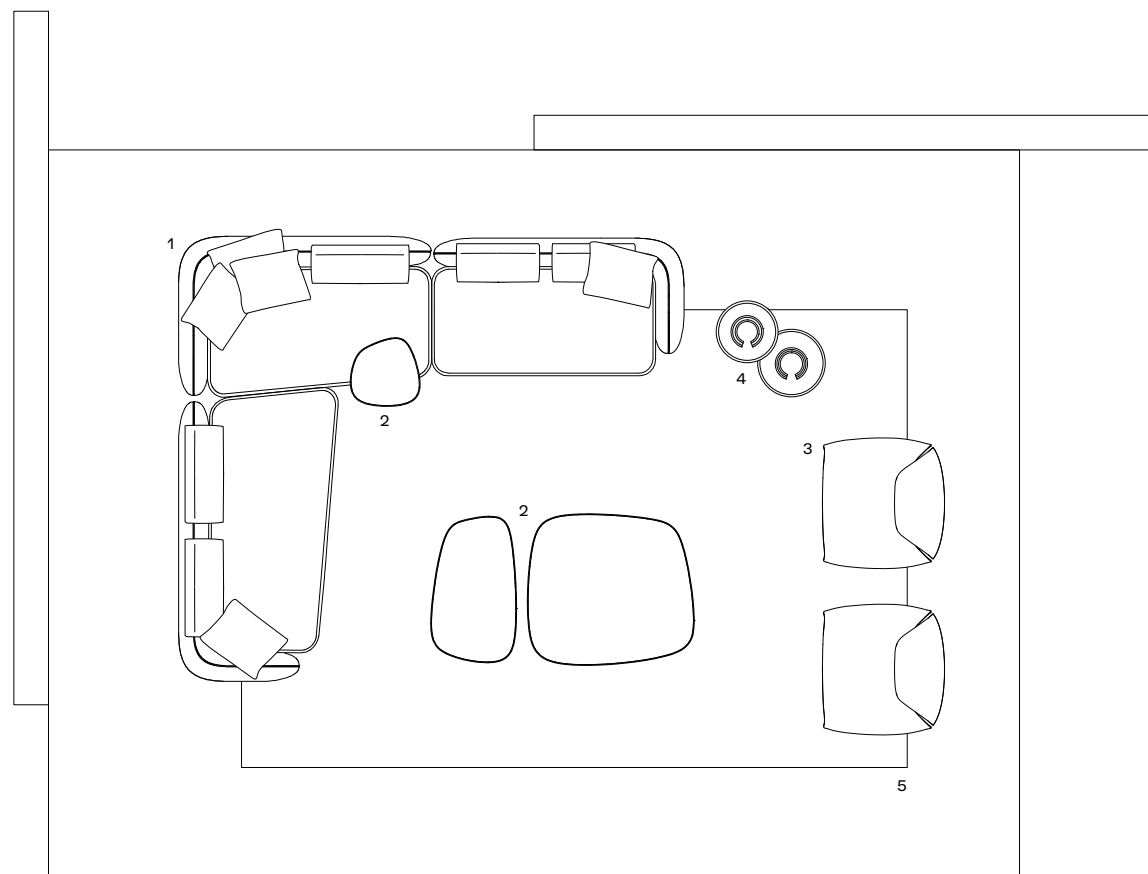
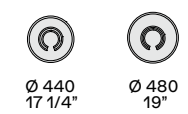

Display 37 mq-sqm

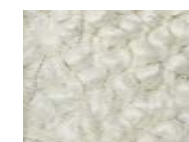

siro 01 bianco
tessuto - fabric



brest 11 cioccolato
tessuto - fabric

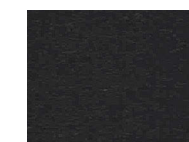

persia 2002 bruciato
velluto - velvet



silk 10 terracotta
pelle - leather



zecevo
marmo levigato
mat marble



olmo nero
black elm



5010 blu
vetro riflettente
reflecting glass

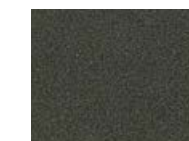

verniciato brunito
painted brunito



3051 bronzato
vetro - glass



COMPOSITION 07

1 Saint-Germain divano

Rivestimento divano e cuscini schienale in tessuto sfoderabile Rabat 402 pernice. Cuscini opzionali in tessuto sfoderabile Rabat 402 pernice e Sendai 03 fango.
Composizione l 3780 p 2780

1 Saint-Germain sofa

Sofa and backrest cushions cover in removable fabric Rabat 402 pernice. Optional cushions in removable fabric Rabat 402 pernice and Sendai 03 fango.
Composition w 148 3/4" d 109 1/2"

2 Koishi tavolini

Strutture verniciato brunito. Piano in marmo sahara noir levigato finitura poliesteri.
1200x1090 h 270
1050x620 h 270
Piano in olmo nero.
500x500 h 530

2 Koishi coffee tables

Structures painted brunito. Top in mat marble sahara noir polyester finish.
47 1/4"x43" h 10 3/4"
41 1/4"x24 1/2" h 10 3/4"
Top in black elm.
19 3/4"x19 3/4" h 20 3/4"

3 Kay Lounge poltrona

Rivestimento non sfoderabile in cuoio intrecciato 26 invecchiato e struttura in cromo satinato.
l 730 p 735 h 675

3 Kay Lounge armchair

Non-removable cover in woven hide 26 invecchiato and structure in satin chrome.
w 28 3/4" d 29" h 26 1/2"

4 Frame tappeto

Colore grey.
Dimensioni su misura 3200x4400

4 Frame carpet

Colour grey.
Customized sizes 126"x173 1/4"

Saint-Germain divano
Saint-Germain sofa

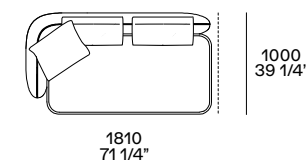

Terminale sx
Lt end unit

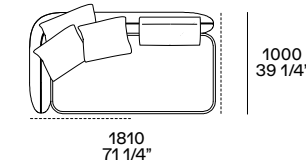

Angolo sx
Lt corner unit

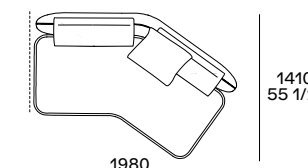

Terminale inclinato dx
Lt angled end unit

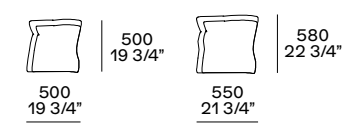

Cuscini opzionali
Optional cushions

Koishi tavolini
Koishi coffee tables

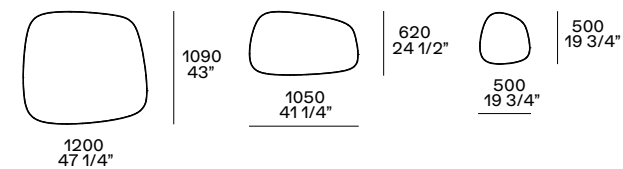

Kay Lounge poltrona
Kay Lounge armchair

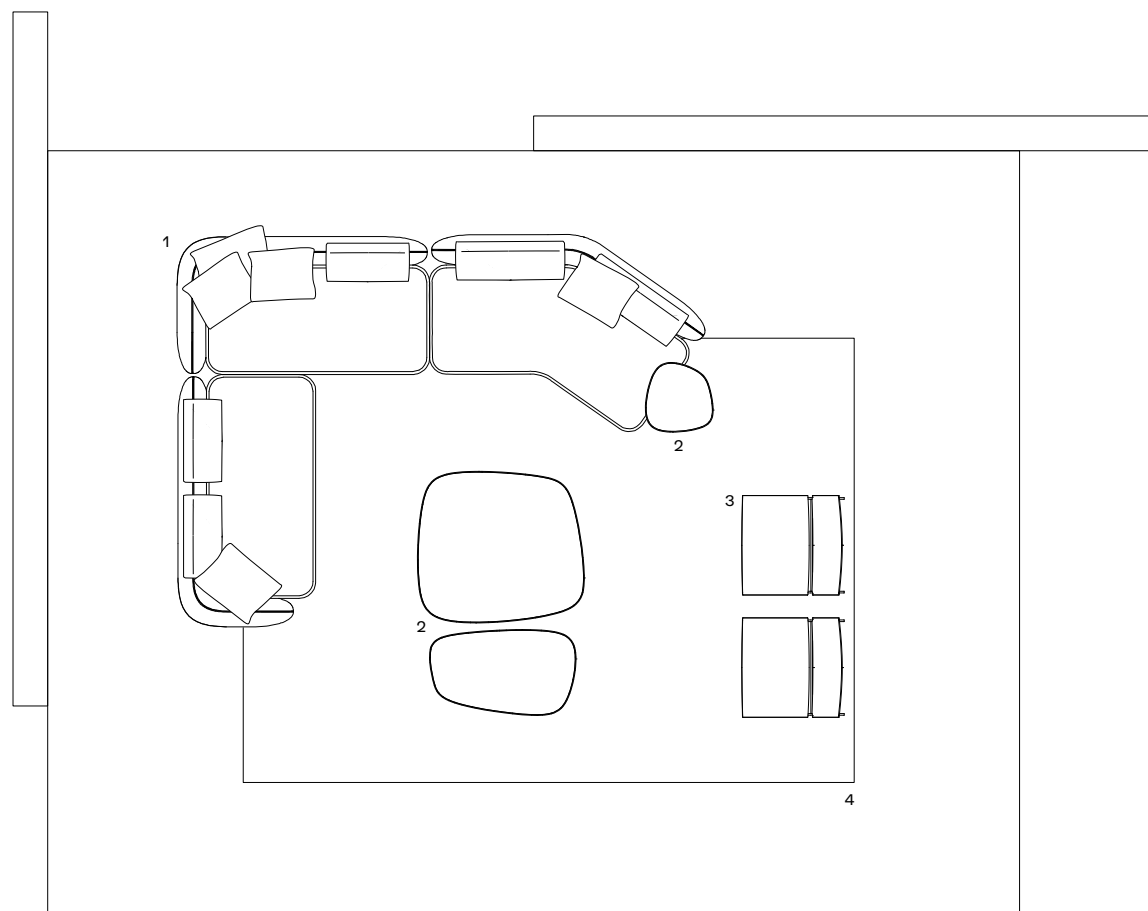
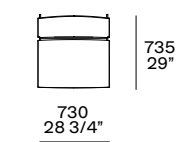

Display 34 mq-sqm



rabat 402 pernice
tessuto - fabric



sendai 03 fango
tessuto - fabric



26 invecchiato
cuoio intrecciato
woven hide



cromo satinato
brushed chrome

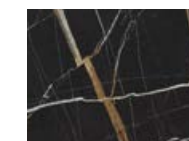

sahara noir
marmo levigato
mat marble



olmo nero
black elm

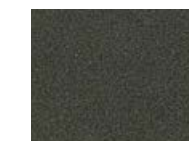

verniciato brunito
painted brunito



COMPOSITION 08

1 Saint-Germain divano

Rivestimento divano e cuscini schienale in tessuto sfoderabile Agadir 06 ocra.
Cuscini opzionali in tessuto sfoderabile Nancy 101 carbone e velluto sfoderabile Persia 1404 carbone.
Composizione l 4740 p 3100

1 Saint-Germain sofa

Sofa and backrest cushions cover in removable fabric Agadir 06 ocra.
Optional cushions in removable fabric Nancy 101 carbone and removable velvet Persia 1404 carbone.
Composition w 186 1/2" d 122"

2 Koishi tavolini

Strutture verniciato brunito.
Piano in vetro blu riflettente.
1200x1090 h 270
Piano in olmo nero.
1050x620 h 530
Piano in marmo zecevo levigato.
720x430 h 480
500x500 h 530
Piano in pietra ebano spatolata.
890x450 h 360

2 Koishi coffee tables

Structures painted brunito.
Top in blu reflecting glass.
47 1/4"x43" h 10 3/4"
Top in black elm.
41 1/4"x24 1/2" h 20 3/4"
Top in mat marble zecevo.
28 1/4"x17" h 19"
19 3/4"x19 3/4" h 20 3/4"
Top in spatula-finish ebony stone.
35"x17 3/4" h 14 1/4"

3 Le Club poltrona

Rivestimento non sfoderabile in pelle Silk 06 roccia.
1940 p 880 h 670

3 Le Club armchair

Non-removable cover in leather Silk 06 roccia.
w 37" d 34 3/4" h 26 1/2"

4 Cannelé tappeto

Dimensioni su misura 3700x5250

4 Cannelé carpet

Customized sizes 145 3/4"x206 3/4"

Saint-Germain divano Saint-Germain sofa

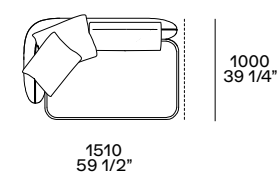

Terminale sx
Lt end unit

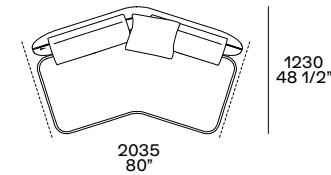

Centrale inclinato
Angled central unit

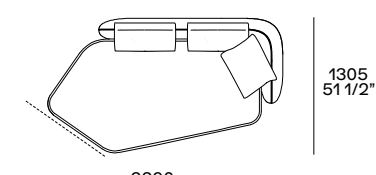

Terminale penisola inclinato dx
Rt angled peninsula end unit

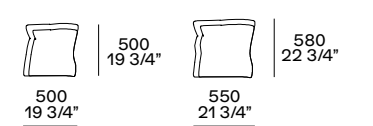

Cuscini opzionali
Optional cushions

Koishi tavolini Koishi coffee tables

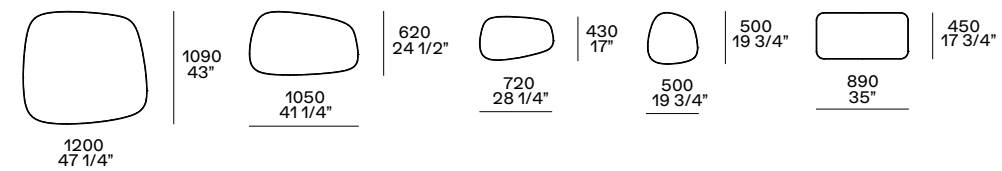

Le Club poltrona Le Club armchair

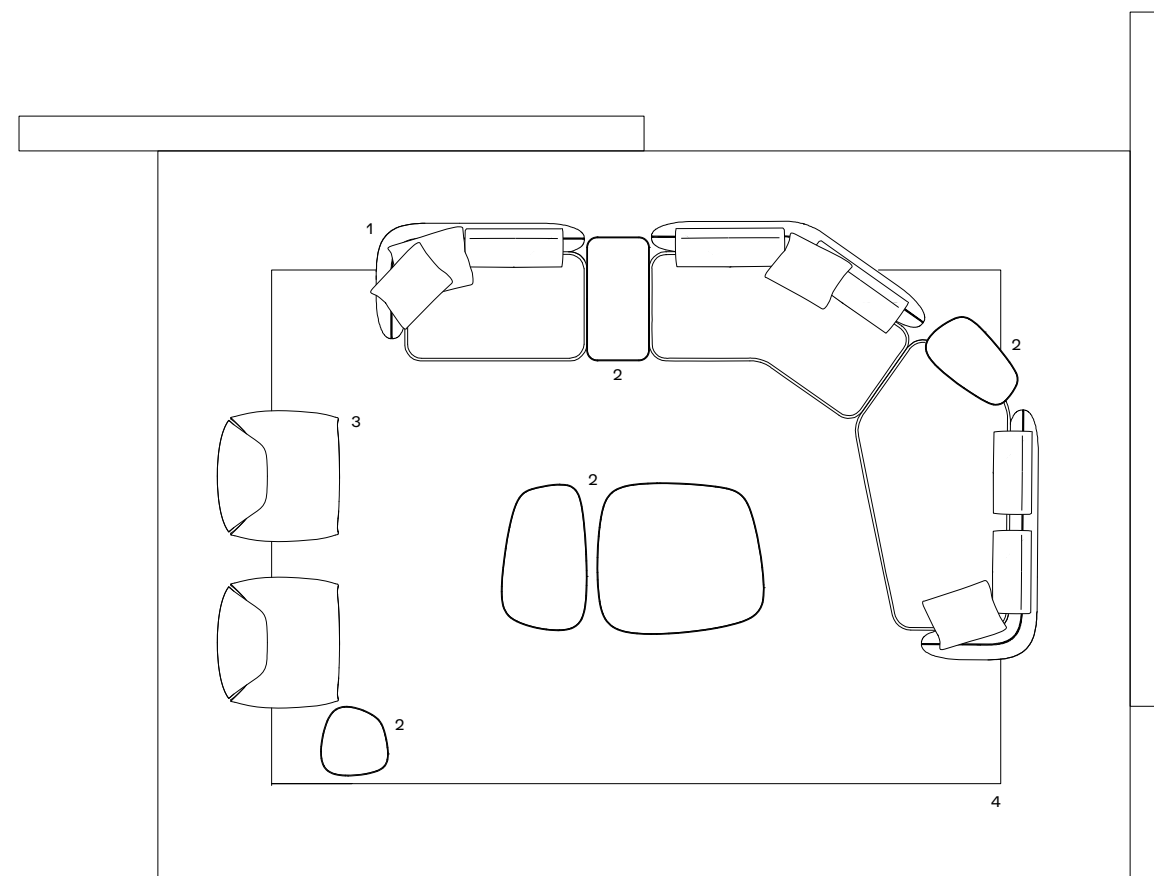
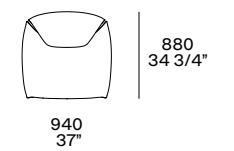

Display 37 mq-sqm



agadir 06 ocra
tessuto - fabric

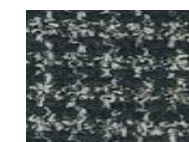

nancy 101 carbone
tessuto - fabric



persia 1404 carbone
velluto - velvet



silk 06 roccia
pelle - leather

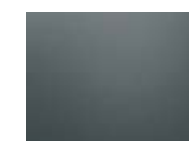

5010 blu
vetro riflettente
reflecting glass



olmo nero
black elm



zecevo
marmo levigato
mat marble

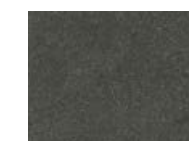

pietra ebano spatolata
spatula-finish ebony
stone

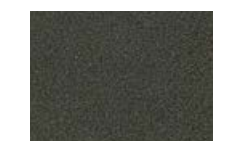

verniciato brunito
painted brunito

TECHNICAL DATA

NUOVE FINITURE
NEW FINISHINGS

175

FINITURE
FINISHINGS

180

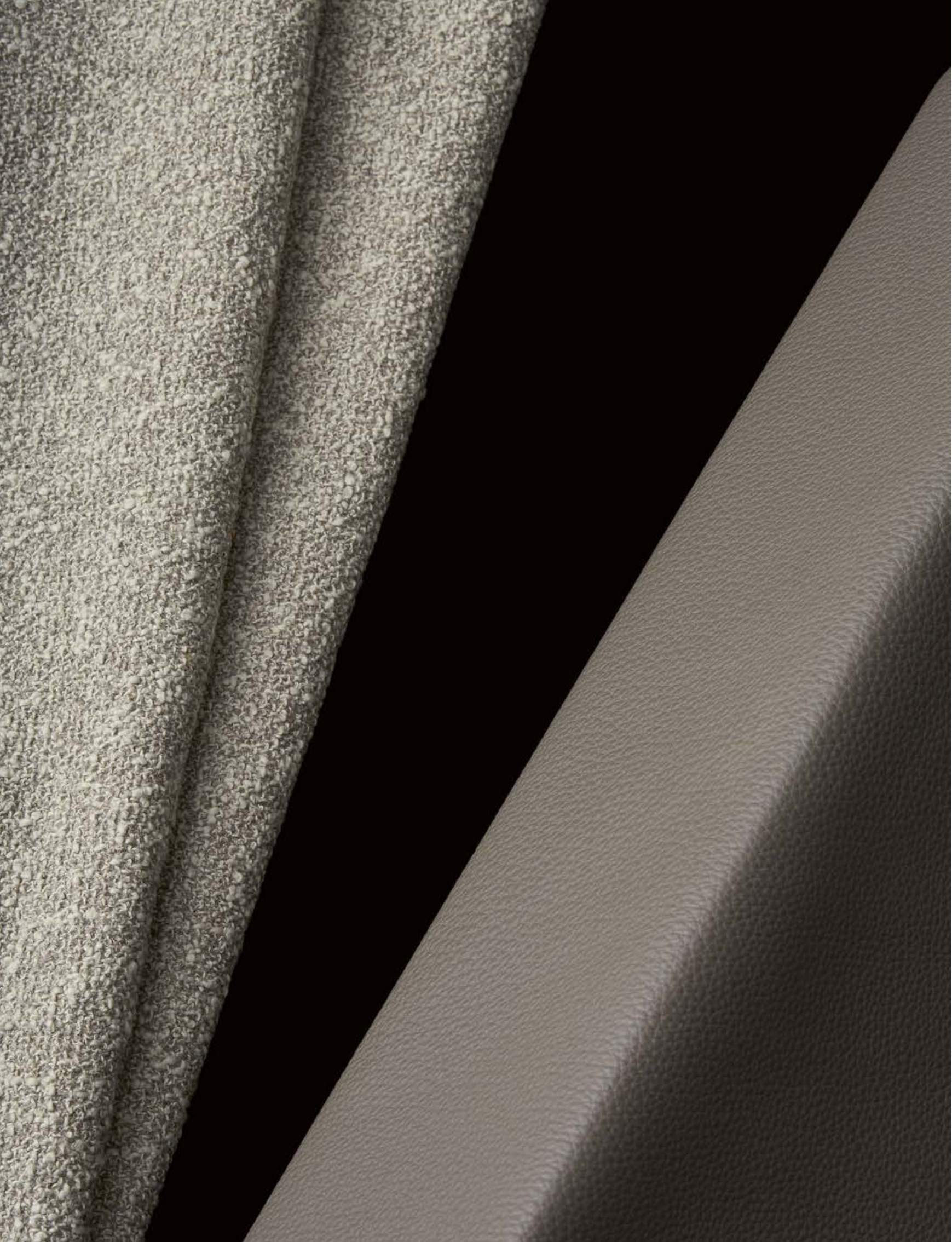

2021 FINISHINGS COLLECTION

Dalla matericità haute couture del bouclé al tocco setoso delle pelli, dalla mano cachemire delle ciniglie all'insolita freschezza dei velluti, il nuovo campionario di Poliform invita a interpretare il rivestimento come possibilità estetica e come veicolo di sensazioni visive e tattili. La selezione, frutto della ricerca stilistica e cromatica che da sempre accompagna il design, attinge alla tradizione tessile e conciaria per dare a ciascun prodotto il rivestimento giusto, sia esso un tessuto o una pelle, in linea con un'idea di stile che nell'armonia tra le tonalità, nell'eleganza degli abbinamenti e nella qualità dell'esperienza esprime il suo carattere e la sua unicità.

From the haute couture material texture of bouclé to the silky touch of leather, from the cashmere hand of chenille to the unusual coolness of velvet, the new Poliform catalogue invites you to interpret the covering as an aesthetic opportunity and as a vehicle for visual and tactile sensations. The selection, product of the stylistic and chromatic research that has always accompanied the design, draws from the textile and tanning tradition to give each product the right covering, be it fabric or leather, in line with an idea of style that expresses its character and uniqueness through the harmony between the shades, the elegance of the combinations, and the quality of the experience.



NUOVI TESSUTI
NEW FABRICS

**Agadir
fabric cat. e**



01 sabbia



02 cenere



03 pepe

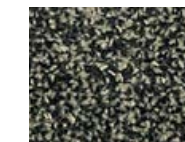

04 tortora



05 crema



06 ocra



07 talpa

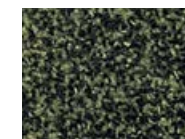

08 foresta

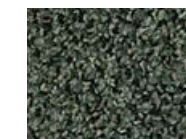

09 giada

**Brest
fabric cat. g**

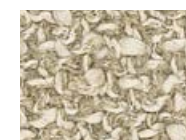

01 crema



12 sabbia

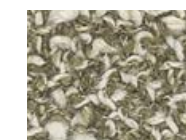

02 salvia



09 bruciato

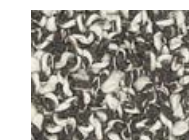

11 cioccolato



05 danubio



10 prussia



04 pepe

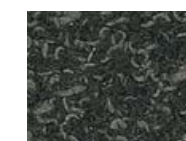

13 carbone



16 cenere

**Glasgow
fabric cat. g**



01 crema



02 tortora

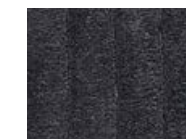

03 carbone

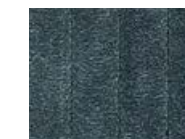

04 avio

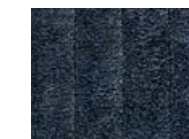

05 prussia



06 ruggine

**Nancy
fabric cat. g**

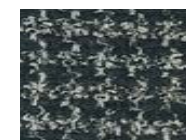

101 carbone



100 cenere



125 sabbia

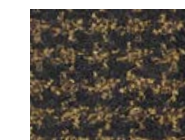

116 ocra

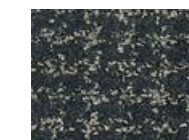

120 tortora

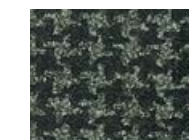

119 giada



NUOVE PELLI
NEW LEATHERS

**Deep
leather cat. x**



01 crema



02 sabbia

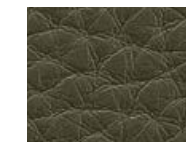

03 salvia

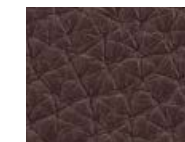

04 bruciato



05 cioccolato

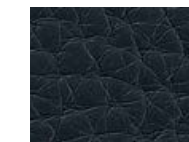

06 danubio



07 carbone

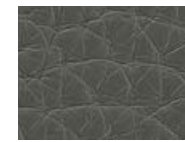

08 cenere

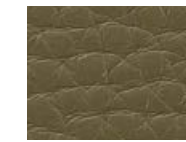

09 senape

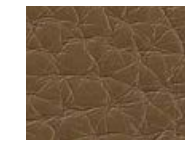

10 cognac

FINITURE
FINISHINGS

Laccato opaco
Mat lacquer



82 glacier white 01 bianco 35 canapa 26 corda 88 castoro 46 tortora



64 arena 89 roccia 48 visone 49 moka 04 grafite 91 carbone



60 ghiaccio 09 pioggia 78 ferro 83 ocra 85 caramello 67 muschio



92 vischio 87 granata 86 danubio 70 prussia



77 champagne 24 ottone 23 bronzo 90 piombo 02 ardesia

Laccato semilucido
Semi-glossy lacquer



01 bianco 35 canapa 26 corda 89 roccia 48 visone 87 granata

Laccato lucido
Glossy lacquer



82 glacier white 01 bianco 35 canapa 26 corda 46 tortora 60 ghiaccio



48 visone 49 moka 83 ocra 85 caramello 87 granata

Laccato antigraffio
Antiscratch lacquer



01 bianco 35 canapa 04 grafite 91 carbone

Laccato metallico
Metallic lacquer



23 bronzo 24 ottone 25 titanio

FINITURE
FINISHINGS

**Essenza
Wood**



rovere gold
gold oak



rovere spessart
spessart oak



noce gold
gold walnut



noce c.
walnut c.



olmo nero
black elm

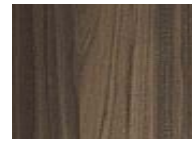

massello noce canaletto
solid walnut canaletto



rovere naturale
natural oak



cedro
cedar

**Marmo levigato
Mat marble**



bianco carrara



calacatta oro

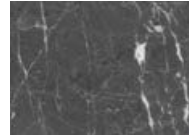

grigio stardust



emperador dark



sahara noir
finitura poliestere
polyester finish



zecevo

**Marmo lucido
Glossy marble**



bianco carrara



calacatta oro

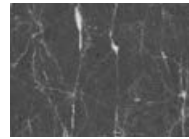

grigio stardust



emperador dark



sahara noir
finitura poliestere
polyester finish



noir saint laurent

**Gabbro
Gabbro**



nero assoluto
texture juta

**Onice
Onyx**



ambra
amber

**Semiprezioso
Semiprecious stone**



lapislazzulo blu
blue lapis lazuli

**Pietra spatolata
Spatula-finish stone**



ebano
ebony

● news

**Cuoio
Hide**



28 avorio



29 tortora



19 caffè



38 oliva



15 prugna



26 invecchiato



03 grigio scuro



02 nero

**Tecnopelle
Techno leather**



05 latte



01 elefante



02 moro



06 nocciola

**Tessuto
Fabric**



lino chiaro



lino é cru ●



lino bruciato ●



lino scuro

FINITURE FINISHINGS

Tessuti Fabrics

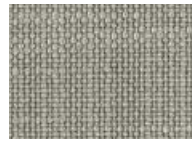

atlanta cat. b
12 colori - colours



caleo cat. b
15 colori - colours



chios cat. b
13 colori - colours



eraclea cat. b
12 colori - colours

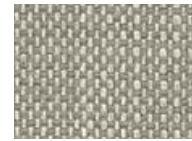

aspen cat. c
12 colori - colours

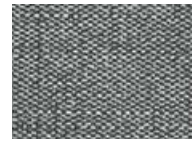

lima cat. c
11 colori - colours



siviglia cat. c
14 colori - colours



antea cat. d
13 colori - colours



cordoba cat. d
13 colori - colours



corinto cat. d
5 colori - colours



indra cat. d
12 colori - colours



itaca cat. d
10 colori - colours

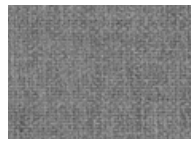

kushiro cat. d
13 colori - colours



lipsi cat. d
11 colori - colours



micene cat. d
9 colori - colours



milos cat. d
5 colori - colours



olimpia cat. d
14 colori - colours

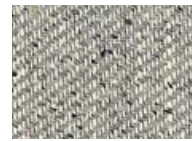

oxford cat. d
8 colori - colours



rabat cat. d
10 colori - colours



sendai cat. d
5 colori - colours



sparta cat. d
12 colori - colours



agadir cat. e
9 colori - colours



arcadia cat. e
12 colori - colours



argo cat. e
13 colori - colours

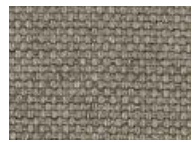

hannover cat. e
11 colori - colours



kitami cat. e
12 colori - colours



naxos cat. e
11 colori - colours



nayoro cat. e
10 colori - colours

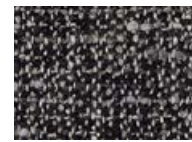

orleans cat. e
10 colori - colours



persia cat. e
16 colori - colours



skyros cat. e
12 colori - colours



zante cat. e
11 colori - colours



brest cat. g
10 colori - colours



glasgow cat. g
6 colori - colours



lero cat. g
2 colori - colours



nancy cat. g
6 colori - colours



siro cat. g
4 colori - colours

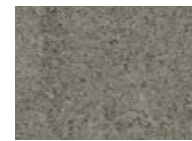

tebe cat. g
11 colori - colours



gibson cat. z
8 colori - colours

● news

Pelle Leather

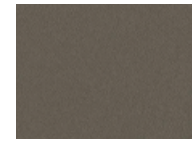

spring cat. p
13 colori - colours



colors cat. s
25 colori - colours

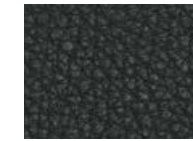

silk cat. s
13 colori - colours



silk intrecciata cat. s
woven leather silk
13 colori - colours

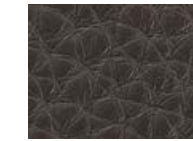

deep cat. x
10 colori - colours



special cat. x
21 colori - colours

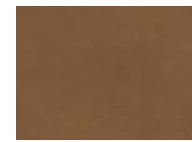

nabuk cat. y
10 colori - colours



nabuk intrecciata cat. y
woven leather nabuk
10 colori - colours

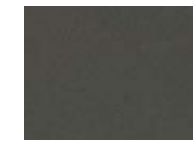

invecchiata cat. y
6 colori - colours



soft cat. y
14 colori - colours

Pelle Cashmere Cashmere leather



bianco

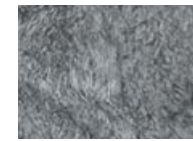

grigio



nero



bianco/nero



cappuccino



nero
solo per sedia Manta
only for Manta chair

Pelle Hairy Hairy leather

Tecnopelle Pixel Pixel techno leather

Bordura gros-grain - bordura in seta - filati Grosgrain border - silk border - yarns



burro



perla



sahara



rubino



tempesta
escluso bordura in seta
except silk border



navy



acciaio

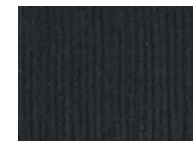

nero

Provence coordinati letto Bed linen Provence

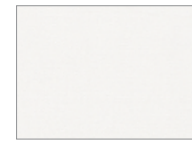

01 bianco

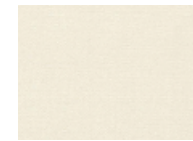

02 panna



08 polvere



04 tortora



06 roccia



07 grafite



03 ghiaccio

FINITURE
FINISHINGS

**Vetro
Glass**

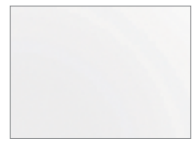

1000 trasparente
transparent

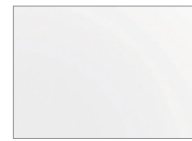

2000 trasparente
extrachiaro-transparent
extralight



3051 bronzato
bronzed



3050 fumé



2700 line

**Vetro riflettente
Reflecting glass**



5000 trasparente
transparent



5010 blu



5051 bronzato
bronzed



5059 fumé

**Vetro acidato
Etched glass**



5380 acciaio



5323 bronzo



5325 titanio



4000 bianco
white



4051 bronzato
bronzed

**Specchio
Mirror**

**Vetro satinato
Mat glass**



2301 bianco

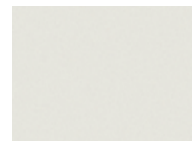

2373 ghiaccio



1335 canapa



1364 arena



1304 grafite

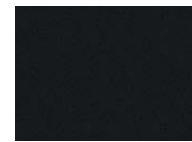

1303 nero

**Vetro lucido
Glossy glass**

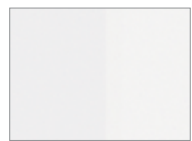

2201 bianco



2273 ghiaccio



1235 canapa



1264 arena

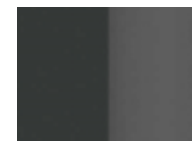

1204 grafite



1203 nero



1259 bordeaux

● news

**Nobilitato
Melamine**



olmo
elm



noce c.
walnut c.



rovere cenere
cenere oak



rovere spessart
spessart oak



canvas beige



canvas grigio



graffiti 01 bianco



graffiti 35 canapa



graffiti 60 ghiaccio



silk canapa



silk grey



silk bronzo



club 01 bianco



skin
27 colori laccato opaco
27 mat lacquered colours



skin 94 latte
laccato opaco
mat lacquered



skin 97 elefante
laccato opaco
mat lacquered



skin 93 moro
laccato opaco
mat lacquered



skin 98 nocciola
laccato opaco
mat lacquered

**Nobilitato interno cassetti
Melamine drawers structure**

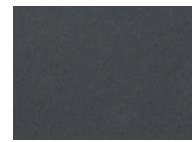

ardesia



madras
Quid sistema giorno -
day system



roller latte



roller ardesia

**Metacrilato
Methacrylate**

**Parti metalliche
Metal parts**



brown nickel opaco
mat brown nickel



brown nickel lucido
glossy brown nickel



brown nickel satinato
brushed brown nickel



champagne opaco
mat champagne



champagne satinato
brushed champagne



bronzato
bronzed



piombo mat
mat piombo

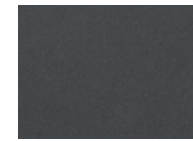

ardesia opaco
mat ardesia



cromo satinato
brushed chrome

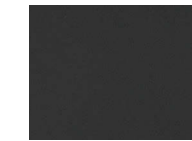

cromo nero
black chrome



cromo nero satinato
brushed black chrome



bronzo anticato
antique bronze



spatolato ferro
spatula-finish ferro



spatolato bronzo
spatula-finish bronzo



oro lucido
glossy gold



alluminio brill
aluminium brill



verniciato brunito
painted brunito

Poliform Spa
via Montesanto 28
Casella postale n. 1
22044 Inverigo (CO) Italy
t +39 031 6951
f +39 031 699444
info@poliform.it
poliform.it



2018 Adi Compasso D'oro
Career Award

Poliform realizza tutte le sue collezioni in Italia usando componenti e materie prime selezionate.

All the Poliform collections are manufactured 100% in Italy using top-class components and materials.

Poliform si riserva il diritto di apportare, senza preavviso, ogni modifica mirata al miglioramento funzionale e qualitativo dei propri prodotti. Testi e disegni presenti in questo stampato hanno scopo divulgativo: per ogni aspetto tecnico e dimensionale fare riferimento ai listini aziendali e relativi aggiornamenti. I campioni di colori e materiali hanno valore indicativo.

Poliform reserves the rights at all time to apply modifications for the functional or qualitative improvement of its products. Texts and drawings present in this brochure have a divulgative purpose: for every technical and dimensional aspect please refer to the company's price lists and their relative updatings. The colour and material samples have an indicative value.

Creative Direction
Apartamento Studios

Graphic Design
Apartamento Studios

Interiors Photography
F2 Fotografia

Still Life Photography
Silvia Orlandi

Interiors Styling
Poliform Lab

1st edition September 2020
cod. 116/R1/2020



