

DAY COMPLEMENTS

Poliform

Poliform

Poliform presenta la collezione di complementi. Sedie, panche, sgabelli, tavoli, madie e scrittoi pensati per completare con eleganza la zona giorno – ma anche la zona notte, oggi che l'abitare ha assunto forme sempre più fluide. Sedute dove design e comfort si uniscono in un equilibrio perfetto, tavoli caratterizzati da forme essenziali e finiture di pregio, madie dall'estetica rigorosa ma attuale, scrittoi capaci di interpretare lo spazio in base alle esigenze. In filigrana, come sempre, lo stile di Poliform, eccellente nella qualità del design, nell'armonia delle forme e nella selezione dei materiali.

Poliform presents the collection of complements. Chairs, benches, stools, tables, sideboards, and writing desks designed to elegantly complete the day area – but also the night area, now that living has taken on increasingly fluid forms. Seats where design and comfort combine in perfect balance, tables characterized by minimalistic shapes and fine finishes, sideboards of a rigorous yet modern style, writing desks capable of interpreting the space according to needs. At the base of everything, as always, Poliform's style, excellent in the quality of design, in the harmony of shapes, and in the selection of materials.

COLLECTIONS

SEDIE CHAIRS	7
PANCHE BENCHES	141
SGABELLI STOOLS	161
TAVOLI TABLES	205
SCRITTOI E CONSOLLE DESKS AND CONSOLE	333
MADIE E LIBRERIE SIDEBOARDS AND BOOKCASES	365

CHAIRS

Rigore delle forme, essenzialità delle linee, eleganza impeccabile di finiture e rivestimenti: questo è lo stile delle sedie Poliform. Dalle poltroncine alle sedie, dal design più classico al più provocatorio, la collezione si compone di proposte che sanno unire estetica e comfort, ideali attorno a un tavolo da pranzo così come accanto a uno scrittoio. Sempre particolari le lavorazioni delle basi e dei rivestimenti sartoriali in tessuto o pelle. I progetti sono firmati da Jean-Marie Massaud, Rodrigo Torres, Emmanuel Gallina, Marcel Wanders, Rodolfo Dordoni, Blumer e Borghi.

Rigour of shapes, minimalism of lines, impeccable elegance of finishes and upholstery: this is the style of the Poliform chairs. From the armchairs to the chairs, from the most classic to the most provocative design, the collection consists of offers that know how to combine style and comfort, ideal around a dining table as well as next to a desk. Always particular are the details of the bases and of the tailored upholstery in fabric or leather. The projects are signed by Jean-Marie Massaud, Rodrigo Torres, Emmanuel Gallina, Marcel Wanders, Rodolfo Dordoni, Blumer and Borghi.

CHAIRS

STANFORD BRIDGE	11
SOPHIE	23
GRACE	35
VENTURA	47
MAD DINING CHAIR	61
IPANEMA	73
SEATTLE	85
HARMONY	97
VELVET	105
VELVET DUE	112
MANTA	117
GUEST	125
BB	133

STANFORD BRIDGE

Un guscio sottile e avvolgente come un abito appoggia su un'esile struttura con base girevole. Stanford Bridge è la naturale evoluzione della poltrona Stanford: una sedia, con o senza braccioli, dall'eleganza discreta e contemporanea. Rivestita in tessuto o pelle, è pensata per gli spazi di casa ma è ideale anche negli ambienti di lavoro.

A thin shell enveloping like a dress rests on a slender structure with a revolving base. Stanford Bridge is the natural evolution of the Stanford armchair: a chair, with or without armrests, of a discreet and contemporary elegance. In fabric or leather, it is designed for home spaces but it is also ideal for work environments.





Nelle pagine precedenti: sedie Stanford Bridge con braccioli, rivestimento non sfoderabile in tessuto Kitami 04 sabbia, basamento girevole in brown nickel lucido. Tavolo Kensington struttura in spatolato bronzo e piano in olmo nero. Madia Home Hotel in olmo nero, ante e cassetti con frontali sagomati laccato opaco caramello e bordo in olmo nero. Pouf New York rivestimento sfoderabile in tessuto Norway 08 avorio e piedini brown nickel opaco. In questa pagina: sedia Stanford Bridge con braccioli, rivestimento non sfoderabile in tessuto Skyros 04 visone, basamento girevole in brown nickel lucido.

Previous pages: Stanford Bridge chairs with armrests, non-removable cover in fabric Kitami 04 sabbia, swivel base in glossy brown nickel. Kensington table with structure in bronzo with spatula effect and top in black elm. Home Hotel sideboard in black elm, doors and drawers with caramello mat lacquered shaped fronts and edge in black elm. New York pouf with removable cover in fabric Norway 08 avorio and mat brown nickel feet. This page: Stanford Bridge chair with armrests, non-removable cover in fabric Skyros 04 visone, swivel base in glossy brown nickel.





In questa pagina: sedia Stanford Bridge senza braccioli, rivestimento non sfoderabile in pelle Soft 14 oliva, basamento girevole in brown nickel lucido. Nella pagina successiva: sedia Stanford Bridge senza braccioli, rivestimento non sfoderabile in pelle Soft 03 nocciola, basamento girevole in brown nickel opaco. Tavolo Flute laccato opaco carbone con piano in marmo lucido sahara noir finitura poliester. Pouf Onda in velluto sfoderabile Persia 1401 oliva. Tappeto Plain tortora.

This page: Stanford Bridge chair without armrests, non-removable cover in leather Soft 14 oliva, swivel base in glossy brown nickel. Next page: Stanford Bridge chair without armrests, non-removable cover in leather Soft 03 nocciola, swivel base in mat brown nickel. Carbone mat lacquered Flute table with top in glossy marble sahara noir with polyester finish. Onda pouf in removable velvet Persia 1401 oliva. Carpet Plain tortora.





STANFORD BRIDGE

Design Jean-Marie Massaud, 2018

Scocca in poliuretano flessibile stampato, sedile in poliuretano flessibile a quote differenziate, prerivestimento in fibra di poliestere. Rivestimento non sfoderabile in tessuto o pelle. Basamento girevole con ritorno, fusione di alluminio verniciato brown nickel opaco o lucido.

Body in flexible moulded polyurethane, seat in flexible polyurethane in different densities, pre-cover in polyester fibre. Non-removable cover in fabric or leather. Base with automatic returning mechanism, aluminium casting painted mat or glossy brown nickel.

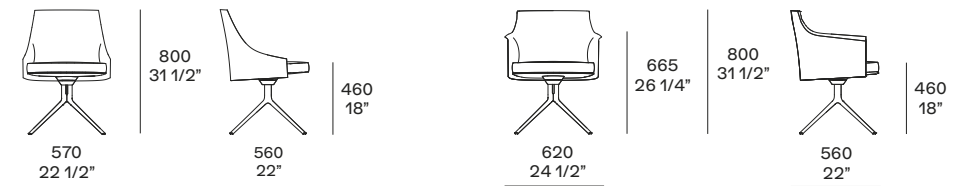



SOPHIE

Emmanuel Gallina disegna una sedia dalle linee avvolgenti e dalle proporzioni generose, reinterpretando in chiave contemporanea una forma classica. Sophie è caratterizzata dalla seduta solida, cui fa da contrappunto una struttura leggera in legno massello. Disponibile nelle due versioni con o senza braccioli, si può rivestire in tessuto o pelle.

Emmanuel Gallina designs a chair with enveloping lines and generous proportions, reinterpreting a classic shape with a contemporary eye. Sophie is characterized by a solid seat, which contrasts a light solid wood structure. Available in two versions with or without armrests, fabric or leather.

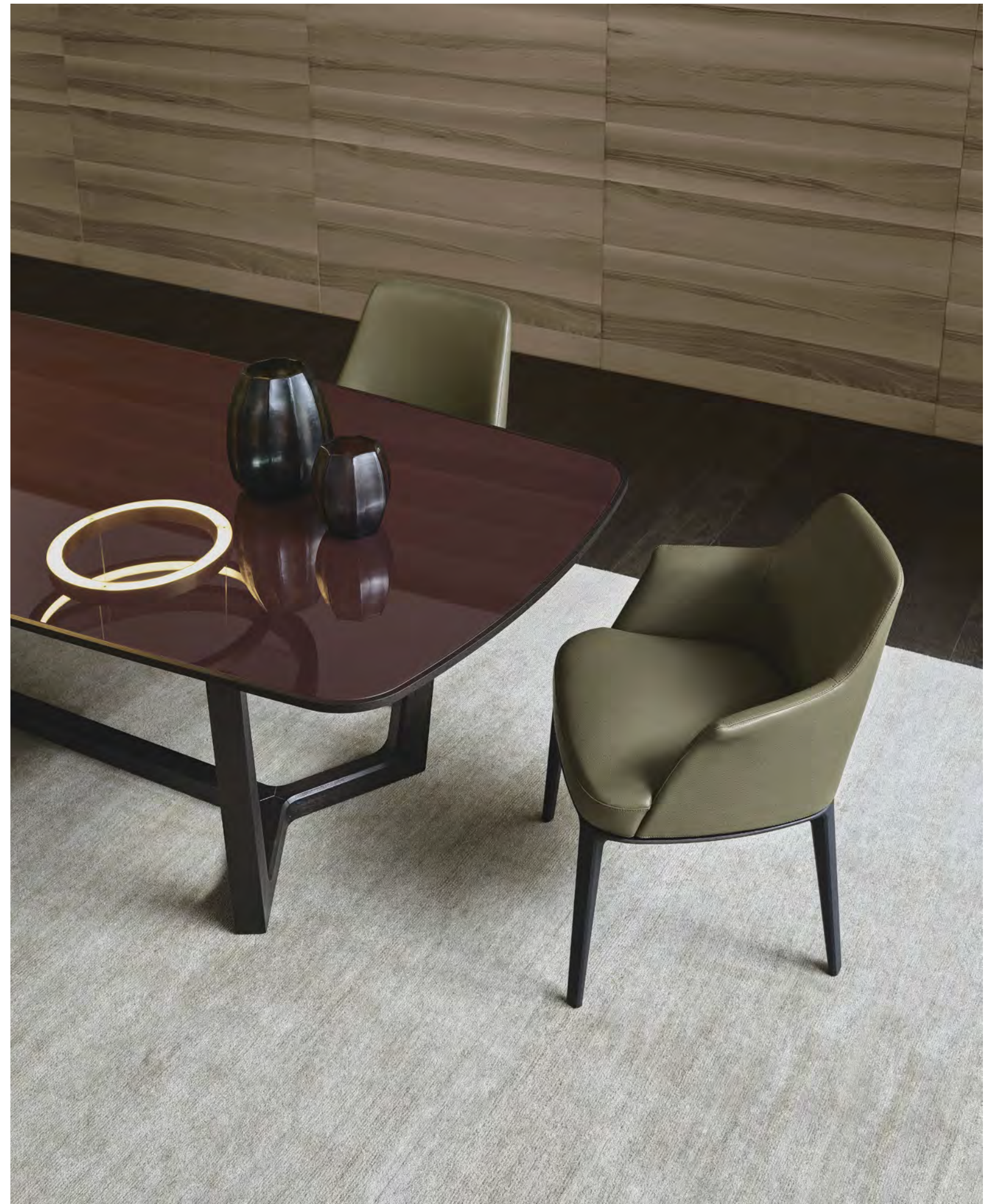



Nelle pagine precedenti: sedie Sophie con e senza braccioli, rivestimento non sfoderabile in pelle Soft 14 oliva, struttura in olmo nero. Tavolo Concorde con struttura e cornice piano in olmo nero, piano in vetro lucido bordeaux. Panca Jane rivestimento sfoderabile in tessuto Orleans 12 carbone, struttura brown nickel lucido. In questa pagina: sedia Sophie con braccioli, rivestimento non sfoderabile in pelle Soft 10 prugna, struttura in olmo nero.

Previous pages: Sophie chairs with and without armrests, non-removable cover in leather Soft 14 oliva, black elm structure. Concorde table with structure and tabletop frame in black elm, top in glossy glass bordeaux. Jane bench with removable cover in fabric Orleans 12 carbone, glossy brown nickel structure. This page: Sophie chair with armrests, non-removable cover in leather Soft 10 prugna, black elm structure.

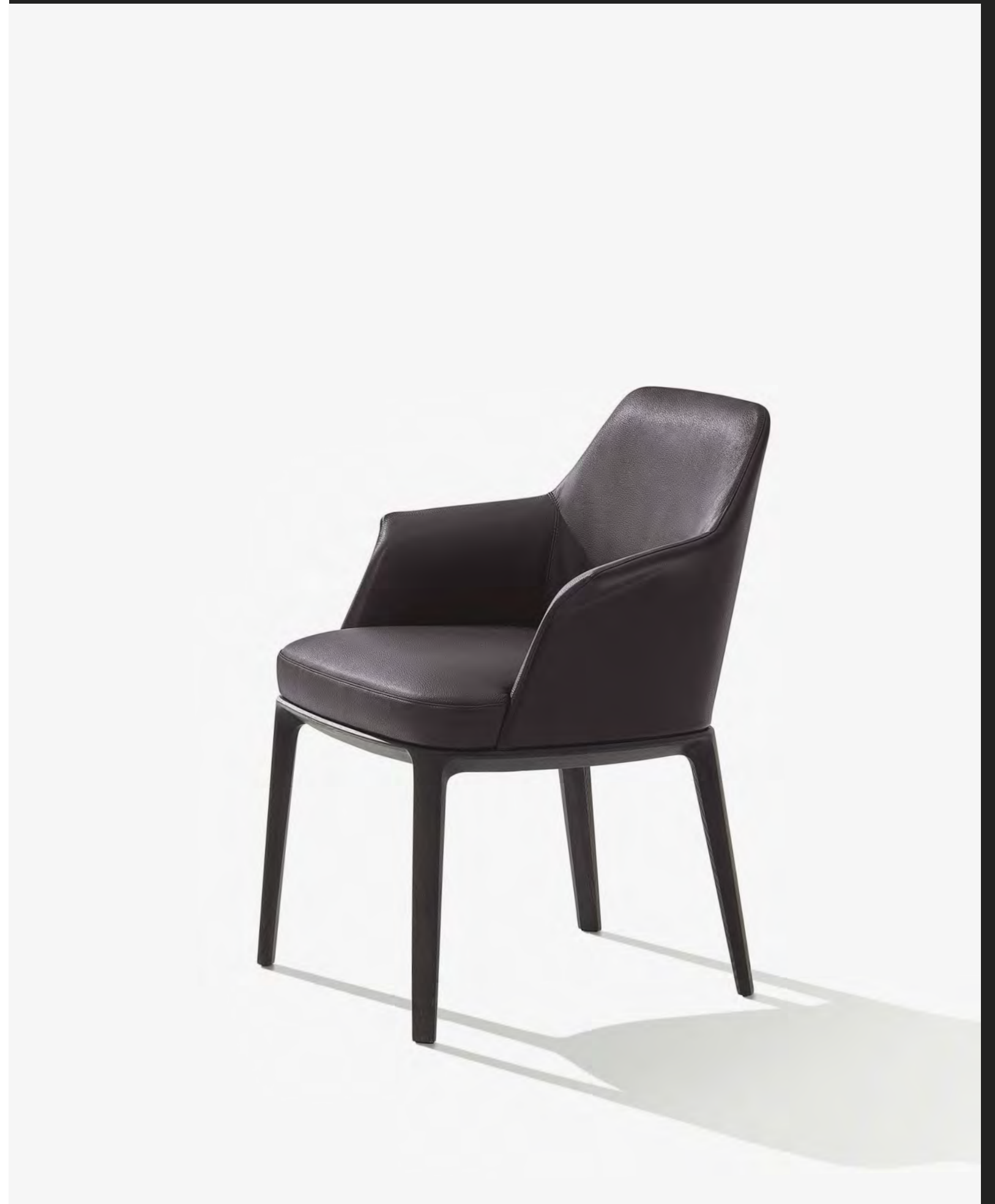



In questa pagina: sedia Sophie senza braccioli, rivestimento non sfoderabile in tessuto Lipsi 02 pernice, struttura in olmo nero. Nella pagina successiva: sedie Sophie con e senza braccioli, rivestimento non sfoderabile in pelle Soft 14 oliva, struttura in olmo nero. Tavolo Concorde con struttura e cornice piano in olmo nero, piano in vetro lucido bordeaux.

This page: Sophie chair without armrests, non-removable cover in fabric Lipsi 02 pernice, black elm structure. Next page: Sophie chairs with and without armrests, non-removable cover in leather Soft 14 oliva, black elm structure. Concorde table with structure and tabletop frame in black elm, top in glossy glass bordeaux.





SOPHIE

Design Emmanuel Gallina, 2017

Seduta e schienale con parti in poliuretano flessibile a quote differenziate e parti in poliuretano flessibile stampato, prriverestimento in fibra di poliestere. Rivestimento non sfoderabile in tessuto o pelle. Struttura in massello, finitura in rovere spessart o olmo nero.

Seat and backrest with parts in flexible polyurethane in different densities and parts in flexible moulded polyurethane, pre-cover in polyester fibre. Non-removable cover in fabric or leather. Structure in solid wood, spessart oak or black elm finish.

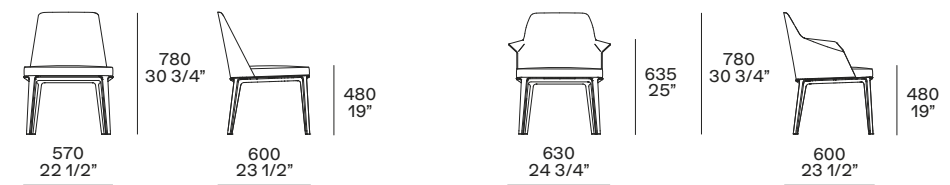



GRACE

Vero classico contemporaneo, con la sua struttura slanciata e la seduta accogliente Grace è allo stesso tempo elemento estetico e risposta funzionale alle esigenze dell'abitare. La sedia è disponibile con o senza braccioli e rivestita in tessuto o pelle, anche con schienale in pelle intrecciata.

A true contemporary classic, with its slender structure and welcoming seat, Grace is at the same time an aesthetic element and a functional answer to the needs of living. The chair is available with or without armrests and upholstered in fabric or leather, also with woven leather backrest.





Nelle pagine precedenti: sedia Grace con braccioli, rivestimento non sfoderabile in pelle Nabuk 05 grafite, struttura in rovere spessart. Tavolo Concorde in rovere spessart con piano in marmo calacatta oro levigato e vassoio centrale girevole in rovere spessart. Pouf Onda in velluto sfoderabile Persia 1401 oliva. In questa pagina: sedia Grace con braccioli, rivestimento non sfoderabile in tessuto Skyros 07 grafite, struttura in olmo nero.

Previous pages: Grace chairs with armrests, cover in non-removable leather Nabuk 05 grafite, spessart oak structure. Concorde table in spessart oak with top in mat marble calcatta oro, swivel tray in spessart oak. Onda pouf in removable velvet Persia 1401 oliva. This page: Grace chair with armrests, cover in non-removable fabric Skyros 07 grafite, black elm structure.





In questa pagina: sedia Grace senza braccioli, rivestimento non sfoderabile in pelle Nabuk 01 latte e retro schienale in pelle Nabuk intrecciata 01 latte, struttura in olmo nero. Nella pagina successiva: sedie Grace con e senza braccioli, rivestimento non sfoderabile in pelle Special 48 nocciola, struttura in rovere cenere. Tavolo Concorde in rovere cenere con piano in marmo calacatta oro levigato.

This page: Grace chair without armrests, cover in non-removable leather Nabuk 01 latte and rear of the chair backrest in woven leather Nabuk 01 latte, black elm structure. Next page: Grace chair with and without armrests, non-removable cover in leather Special 48 nocciola, cenere oak structure. Concorde table in cenere oak with top in mat marble calacatta oro.

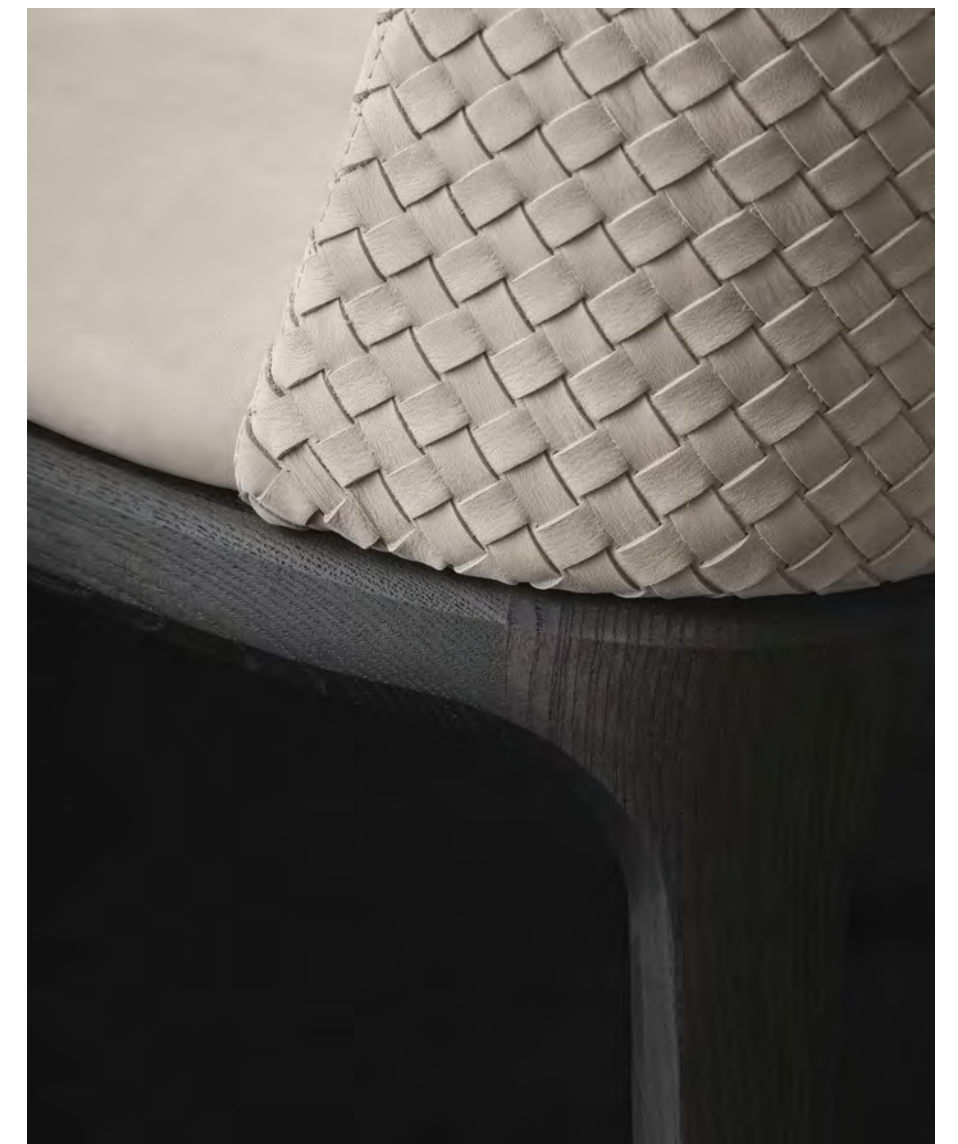



GRACE

Design Emmanuel Gallina, 2009

Seduta e schienale in poliuretano flessibile stampato a quote differenziate, prriverestimento in fibra di poliestere. Rivestimento non sfoderabile in tessuto, pelle o pelle Nabuk intrecciata (solo per retro schienale). Struttura in massello, finitura in noce c., rovere cenere, rovere spessart o olmo nero.

Seat and backrest in flexible moulded polyurethane in different densities, pre-cover in polyester fibre. Non-removable cover in fabric, leather or woven leather Nabuk (available only for the rear of the backrest). Solid wood structure in the finishes walnut c., cenere oak, spessart oak or black elm.

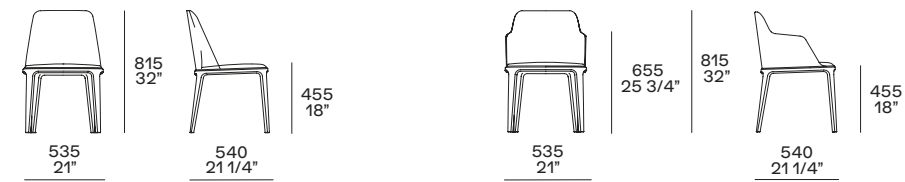



VENTURA

La sedia Ventura è caratterizzata dalla particolarissima giunzione tra lo schienale e i braccioli, un dettaglio di grande raffinatezza che regala carattere e sensualità. In perfetto equilibrio tra comfort e stile, Ventura è disponibile con struttura in essenza e, per la versione con struttura in metallo, in tutti i colori laccati opachi, da abbinare al rivestimento in tessuto o pelle.

The Ventura chair is characterized by the very particular junction between the backrest and the armrests, a detail of great refinement that gives character and sensuality. In perfect balance between comfort and style, Ventura is available with structure in wood and, for the version with the metal structure, in all the mat lacquered colours, to be combined with the upholstery in fabric or leather.





Nelle pagine precedenti: sedie Ventura con e senza braccioli, rivestimento non sfoderabile in tessuto Merida 02 tortora, struttura in rovere spessart. Tavolo Howard in rovere spessart con piano in marmo calacatta oro levigato. Pouf Onda in velluto sfoderabile Persia 1403 ocra. In questa pagina: sedia Ventura senza braccioli, rivestimento non sfoderabile in pelle Nabuk 09 ruggine, cucitura normale doppia, struttura in olmo nero. Nella successiva: sedia Ventura con braccioli, rivestimento non sfoderabile in tessuto Rabat 402 pernice, cucitura a cordoncino in tinta, struttura in olmo nero.

Previous pages: Ventura chairs with and without armrests, non-removable cover in fabric Merida 02 tortora, structure in spessart oak. Howard table in spessart oak with top in mat marble calacatta oro. Onda pouf in removable velvet Persia 1403 ocra. This page: Ventura chair without armrests, non-removable cover in leather Nabuk 09 ruggine, double normal stitching, black elm structure. Next page: Ventura chair with armrests, non-removable cover in fabric Rabat 402 pernice, drawstring stitching in matching colour, black elm structure.

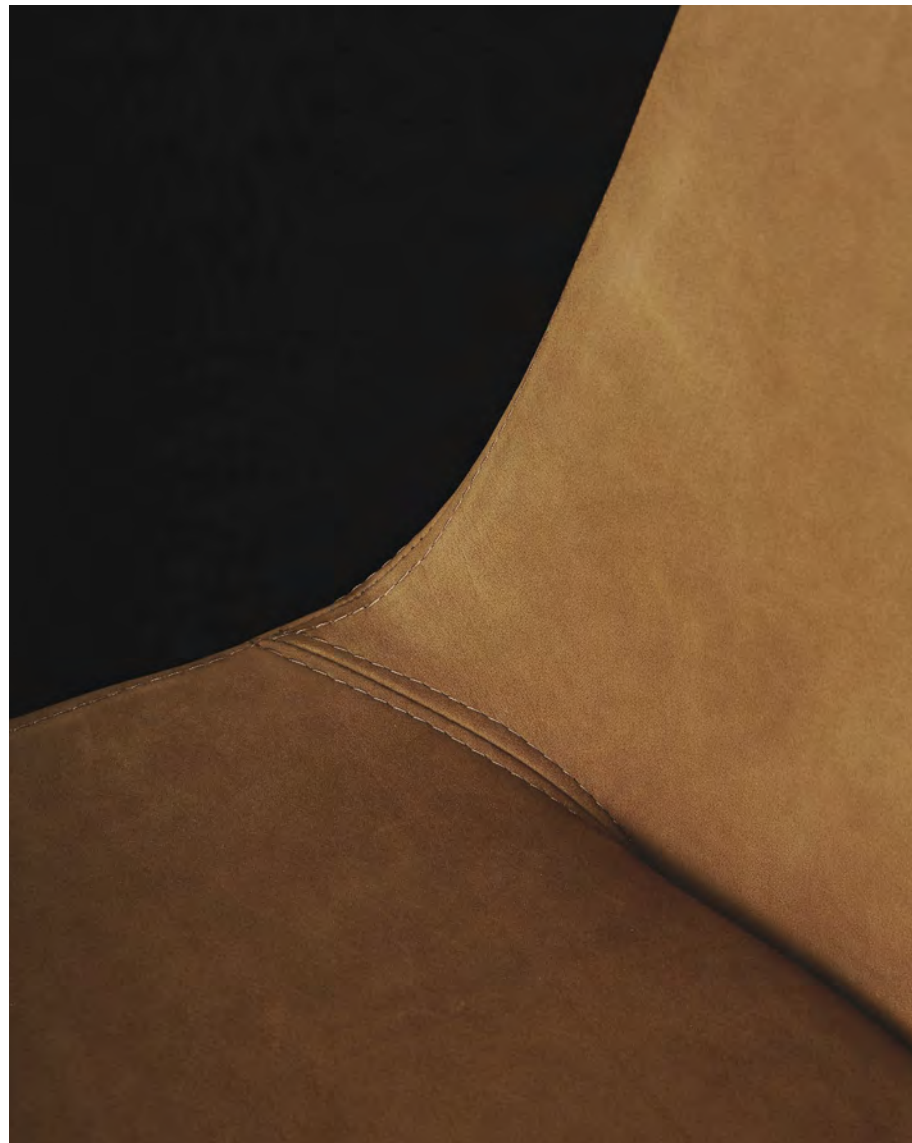



VENTURA

Design Jean-Marie Massaud, 2011

Scocca in poliuretano flessibile stampato, priverestimento in fibra di poliestere. Rivestimento non sfoderabile in tessuto o pelle. Cucitura normale doppia o solo per la versione in tessuto (escluso velluto) cucitura a cordoncino in tinta. Struttura in massello, finitura in rovere cenere, rovere spessart o olmo nero.

Body in flexible moulded polyurethane, pre-cover in polyester fibre. Non-removable cover in fabric or leather. Double normal stitching or drawstring stitching in matching colour, only for the version in fabric (except velvet). Structure in solid wood in the finishes cenere oak, spessart oak or black elm.

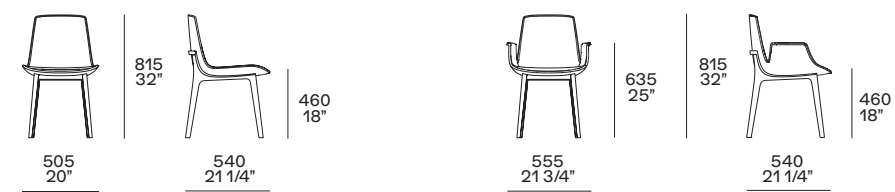

In questa pagina: sedia Ventura con braccioli, rivestimento non sfoderabile in pelle Spring 5402 ghiaccio, cucitura normale doppia, struttura in brown nickel opaco. Nella successiva: sedia Ventura senza braccioli, rivestimento non sfoderabile in tessuto Kitami 09 senape, cucitura a cordoncino in tinta, struttura laccato opaco ocra.

This page: Ventura chair with armrests, non-removable cover in leather Spring 5402 ghiaccio, double normal stitching, structure in mat brown nickel. Next page: Ventura chair without armrests, non-removable cover in fabric Kitami 09 senape, drawstring stitching in matching colour, ocra mat lacquered structure.





VENTURA

Design Jean-Marie Massaud, 2011

Scocca in poliuretano flessibile stampato, priverivestimento in fibra di poliestere. Rivestimento non sfoderabile in tessuto o pelle. Cucitura normale doppia o solo per la versione in tessuto (escluso velluto) cucitura a cordoncino in tinta. Struttura in metallo verniciato brown nickel opaco o laccato opaco colori.

Body in flexible moulded polyurethane, pre-cover in polyester fibre. Non-removable cover in fabric or leather. Double normal stitching or, only for the version in fabric (except velvet), drawstring stitching in matching colour. Structure in mat or glossy brown nickel painted metal.

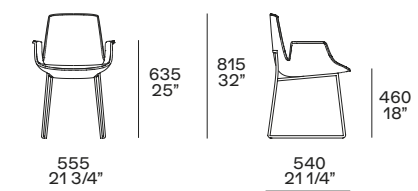
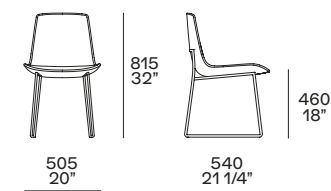



MAD DINING CHAIR

Disegnata da Marcel Wanders, la sedia Mad Dining Chair richiama nella linea morbida della scocca e nella forma delle gambe in legno le peculiarità del tavolo cui armoniosamente si accompagna, dando alla sala da pranzo un'atmosfera di pacata raffinatezza.

Designed by Marcel Wanders, the Mad Dining Chair is reminiscent of the peculiarities of the table it harmoniously accompanies in the soft line of the shell and in the shape of the wooden legs, giving the dining room an atmosphere of calm refinement.





Nelle pagine precedenti: sedie Mad Dining Chair senza braccioli, rivestimento non sfoderabile, esterno in pelle Nabuk 05 grafite e interno in tessuto Argo 1008 ardesia, gambe in rovere spessart. Tavolo Mad Dining Table in rovere spessart con piano in marmo calacatta oro lucido. In questa pagina: sedia Mad Dining Chair senza braccioli, rivestimento non sfoderabile in tessuto Paros 05 bianco, gambe in olmo nero.

Previous pages: Mad Dining Chair without armrests, non-removable cover, outer cover in leather Nabuk 05 grafite and inner cover in fabric Argo 1008 ardesia, legs in spessart oak. Mad Dining Table in spessart oak with top in glossy marble calacatta oro. This page: Mad Dining Chair without armrests, non-removable cover in fabric Paros 05 bianco, black elm legs.

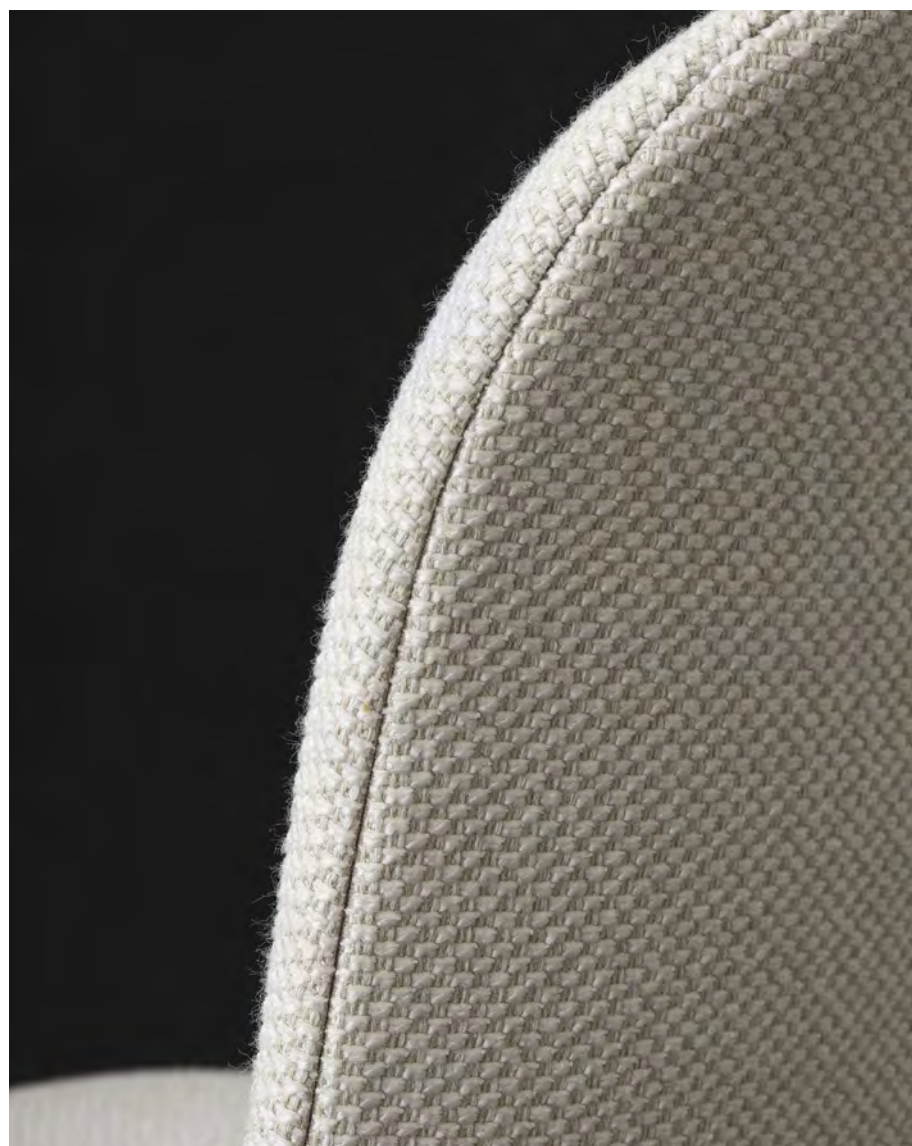



In questa pagina: sedia Mad Dining Chair con braccioli, rivestimento non sfoderabile, esterno in pelle Soft 02 mastice e interno in tessuto Kitami 04 sabbia, gambe in olmo nero. Nella pagina successiva: sedia Mad Dining Chair con braccioli, rivestimento non sfoderabile in pelle Soft 08 visone, gambe in rovere spessart.

This page: Mad Dining chair with armrests, non-removable cover, outer cover in leather Soft 02 mastice and inner cover in fabric Kitami 04 sabbia, black elm legs. Next page: Mad Dining Chair with armrests, non-removable cover in leather Soft 08 visone, spessart oak legs.





MAD DINING CHAIR

Design Marcel Wanders, 2015

Scocca in poliuretano flessibile stampato, priverivestimento in fibra di poliestere. Rivestimento non sfoderabile in tessuto o pelle. Possibilità di rivestimento diverso tra interno ed esterno della scocca. Il rivestimento Gibson matelassé è disponibile solo per la scocca interna. Gambe in massello, finitura in rovere spessart o olmo nero.

Body in flexible moulded polyurethane, pre-cover in polyester fibre. Cover in non-removable fabric or leather. The inner and outer cover can be in two different materials. Fabric Gibson matelassé is available only for the inner cover. Legs in solid wood in the finishes spessart oak or black elm.

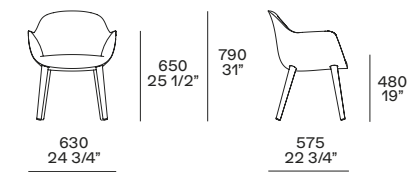
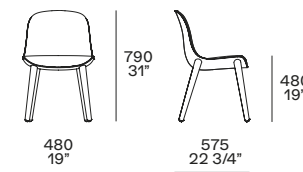



IPANEMA

Jean-Marie Massaud aggiunge un tassello alla sua collezione Ipanema. Originale e raffinata, la sedia è decisamente versatile: la particolare struttura in essenza, con o senza braccioli, si può abbinare a tutti i tessuti e le pelli della collezione.

Jean-Marie Massaud adds a piece to his Ipanema collection. Original and refined, the chair is markedly versatile: the particular structure in wood, with or without armrests, can be combined with all the fabrics and leathers of the collection.





Qui e nella pagina precedente: sedie Ipanema con braccioli, rivestimento non sfoderabile in pelle Soft 4 cognac, struttura in olmo nero. Tavolo Home Hotel in olmo nero con piano centrale girevole integrato in marmo noir saint laurent lucido. Tappeto Plain tortora.

This and previous page: Ipanema chairs with armrests, non-removable cover in leather Soft 4 cognac, black elm structure. Home Hotel table in black elm with integrated swivel top in glossy marble noir saint laurent. Carpet Plain tortora.

In questa pagina: sedia Ipanema con braccioli, rivestimento non sfoderabile in tessuto Corinto 02 fango, struttura in olmo nero.

This page: Ipanema chair with armrests, non-removable cover in fabric Corinto 02 fango, black elm structure.





IPANEMA

Design Jean-Marie Massaud, 2015

Seduta e schienale in poliuretano flessibile stampato, rivestimento non sfoderabile in tessuto o pelle. Struttura in massello, finitura in rovere spessart o olmo nero.

Seat and backrest in moulded flexible polyurethane, cover in non-removable fabric or leather. Structure in solid wood in the finishes spessart oak or black elm.

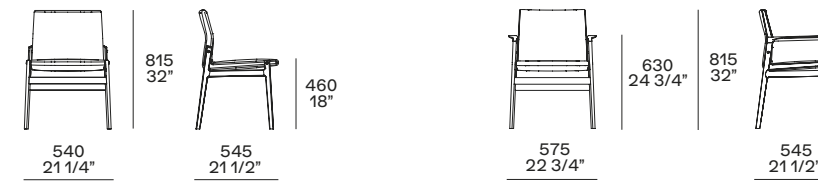



SEATTLE

Seattle è una sedia che si contraddistingue per l'attenta lavorazione artigianale del rivestimento in cuoio. Le cuciture e la punzonatura sono dettagli d'alta sartoria, messi ulteriormente in evidenza dalla forma leggera e quasi aerea della struttura, da rivestire in parte o totalmente.

Seattle is a chair that stands out for the careful craftsmanship of the leather upholstery. The seams and the punching are details of high tailoring, further highlighted by the light and almost aerial shape of the structure, to be upholstered in part or totally.





Nelle pagine precedenti: sedie Seattle con braccioli, seduta e gambe rivestite in cuoio non sfoderabile 29 tortora. Tavolo Home Hotel con struttura e piano in olmo nero. Tappeto Frame perla. In questa pagina: sedia Seattle senza braccioli, seduta rivestita in cuoio non sfoderabile 29 tortora, gambe in olmo nero. Sotto: dettaglio della punzonatura estetica (broquering) perimetrale alla seduta.

Previous pages: Seattle chairs with armrests, seat and legs covered in non-removable hide 29 tortora. Home Hotel table with structure and top in black elm. Carpet Frame perla. This page: Seattle chair without armrests, seat covered in non-removable hide 29 tortora, black elm legs. Below: close-up of the perimeter decorative punching (broquering) of the seat.





In questa pagina: sedia Seattle con braccioli, seduta e gambe rivestite in cuoio non sfoderabile 02 nero. Nella pagina successiva: sedie Seattle con e senza braccioli, seduta rivestita in cuoio non sfoderabile 26 invecchiato, gambe in rovere naturale. Tavolo Blade con struttura e piano in massello noce canaletto.

This page: Seattle chair with armrests, seat and legs covered in non-removable hide 02 nero. Next page: Seattle chairs with and without armrests, seat covered in non-removable hide 26 invecchiato, legs in natural oak. Blade table with structure and top in solid walnut canaletto.





SEATTLE

Design Jean-Marie Massaud, 2015

Seduta in poliuretano integrale con inserto in metallo. Seduta e schienale completamente rivestite in cuoio non sfoderabile nei colori 19 caffè, 02 nero, 26 invecchiato o 29 tortora con punzonatura estetica (broquering) perimetrale. Gambe in massello, finitura in rovere spessart, rovere naturale e olmo nero o completamente rivestite in cuoio nei colori 19 caffè, 02 nero, 26 invecchiato o 29 tortora.

Seat in integral polyurethane with metal insert. Seat and backrest fully covered in non-removable hide in the colours 19 caffè, 02 nero, 26 invecchiato or 29 tortora with perimeter decorative punching (broquering). Legs in solid wood in the finishes spessart oak, natural oak and black elm or fully covered in hide in the colours 19 caffè, 02 nero, 26 invecchiato or 29 tortora.

Gambe in essenza Legs in wood

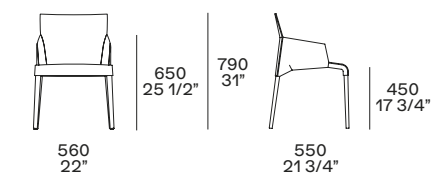
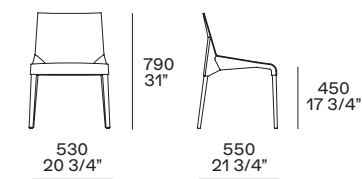

Gambe in cuoio Legs in hide

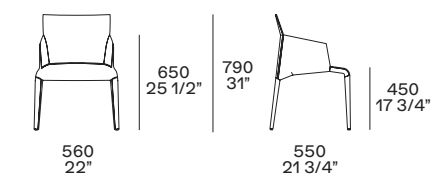
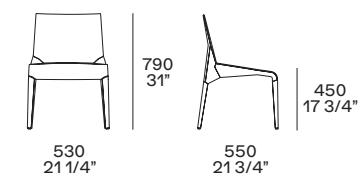

HARMONY

Rodrigo Torres lavora sulle categorie filosofiche di ordine e caos per creare una sedia dalla grande espressività. Il caos è quello della struttura, sempre diversa a seconda del punto di vista; l'ordine è dato invece dalla superficie di seduta, perfettamente liscia. L'esito è Harmony, armonia conquistata tra memoria e innovazione, tecnologia e bellezza.

Rodrigo Torres works on the philosophical categories of order and chaos to create a chair with great expressiveness. The chaos is that of the structure, always different depending on the point of view; the order is given instead by the seating surface, perfectly smooth. The result is Harmony, achieved between memory and innovation, technology and beauty.



Qui e nella pagina precedente: sedia Harmony con seduta in rovere spessart e struttura in cromo nero. Tavolo allungabile Gill in rovere spessart. Nella pagina successiva: sedia Harmony con seduta e struttura in rovere spessart.

This and previous page: Harmony chair with seat in spessart oak and black chrome structure. Extendable table Gill in spessart oak. Next page: Harmony chair with seat and structure in spessart oak.





HARMONY

Design Rodrigo Torres, 2012

Scocca in legno curvato con tecnica 3d finitura rovere spessart. Struttura in massello, finitura rovere spessart o in tondino di metallo finitura in cromo nero.

Body in curved wood with 3D technology, finish spessart oak. Structure in solid wood spessart oak finish or in metal rod in black chrome finish.

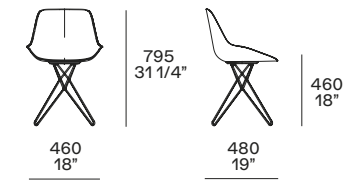
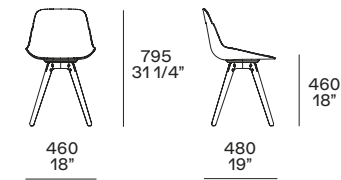

VELVET

Raffinatezza, eleganza, distinzione: Velvet è una dichiarazione d'intenti in puro stile Poliform, che ne firma il disegno. Struttura solida e forma avvolgente sono declinate in quattro diverse varianti che vanno dalla sedia alla poltroncina, con o senza braccioli, per un autentico invito al relax.

Refinement, elegance, distinction: Velvet is a statement of intent in pure Poliform style, which signs the design. Solid structure and enveloping shape are available in four different variants ranging from chair to armchair, with or without armrests, for an authentic invitation to relaxation.



Nella pagina precedente: sedia Velvet con braccioli, rivestimento sfoderabile in velluto Persia 28 cenere, gambe in rovere spessart. In questa pagina: sedia Velvet con braccioli, rivestimento sfoderabile in velluto Persia 54 prussia, gambe in rovere spessart. Nella pagina successiva: sedia Velvet senza braccioli, rivestimento sfoderabile in pelle Soft 08 visone, gambe in rovere spessart.

Previous page: Velvet chair with armrests, removable cover in velvet Persia 28 cenere, legs in spessart oak. This page: Velvet chair with armrests, removable cover in velvet Persia 54 prussia, legs in spessart oak. Next page: Velvet chair without armrests, removable cover in leather Soft 08 visone, legs in spessart oak.





VELVET

Design R&D Poliform, 2007

Seduta e schienale in poliuretano flessibile stampato con telaio in metallo, priverivestimento in fibra di poliestere. Rivestimento sfoderabile in tessuto o pelle. Gambe in massello, finitura in laccato opaco colori, noce c. o rovere spessart.

Seat and backrest in flexible moulded polyurethane with metal frame, pre-cover in polyester fibre. Removable cover in fabric or leather. Legs in solid wood in the finishes mat lacquered colour, walnut c. or spessart oak.

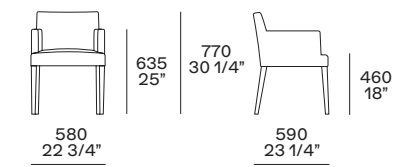
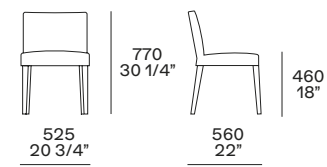

In questa pagina: sedia Velvet Due con braccioli, rivestimento sfoderabile in tessuto Kushiro 04 ghiaccio, gambe in rovere spessart. Nella pagina successiva: sedia Velvet Due senza braccioli, rivestimento sfoderabile in tessuto Sendai 02 tortora, gambe in rovere spessart.

This page: Velvet Due chair with armrests, removable cover in fabric Kushiro 04 ghiaccio, spessart oak legs. Next page: Velvet Due chair without armrests, removable cover in fabric Sendai 02 tortora, spessart oak legs.





VELVET DUE

Design R&D Poliform, 2007

Seduta e schienale in poliuretano flessibile stampato con telaio in metallo, priverivestimento in fibra di poliestere. Rivestimento sfoderabile in tessuto. Gambe in massello, finitura in laccato opaco colori, noce c. o rovere spessart.

Seat and backrest in flexible moulded polyurethane with metal frame, pre-cover in polyester fibre. Removable cover in fabric. Legs in solid wood in the finishes mat lacquered colours, walnut c. or spessart oak.

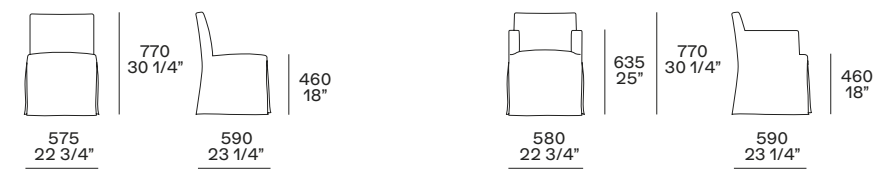

MANTA

Linee essenziali per una sedia che invita e accoglie, in due versioni: con e senza braccioli. Totalmente imbottita e rivestita in pelle, Manta è perfetta attorno a tavoli importanti, ma per la sua presenza di carattere può essere usata anche da sola, in combinazione con uno scrittoio.

Essential lines for a chair that invites and welcomes, in two versions: with and without armrests. Entirely padded and upholstered in leather, Manta is perfect around important tables, but due to its presence of character, it can also be used by itself, combined with a writing desk.



Nella pagina precedente: sedia Manta con braccioli, rivestimento non sfoderabile in pelle Vintage 96 nero. Scrivania Concorde in rovere spessart con sottomano in cuoio 02 nero. Pouf Onda in velluto sfoderabile Persia 1401 oliva. Boiserie Dream velluto Persia 1404 carbone con mensole laccato lucido visone. Qui e nella pagina successiva: sedie Manta con e senza braccioli, rivestimento non sfoderabile in pelle Special 39 panna.

Previous page: Manta chair with armrests, cover in non-removable leather Vintage 96 nero. Concorde writing desk in spessart oak with desk pad in hide 02 nero. Onda pouf in removable velvet Persia 1401 oliva. Dream wall panelling in velvet Persia 1404 carbone with visone glossy lacquered shelves. This and next page: Manta chair with and without armrests, cover in non-removable leather Special 39 panna.





MANTA

Design Rodrigo Torres, 2007

Struttura in poliuretano flessibile stampato con telaio in metallo. Seduta e gambe completamente rivestite in pelle non sfoderabile.

Structure in flexible moulded polyurethane with metal frame. Seat and legs fully covered in non-removable leather.

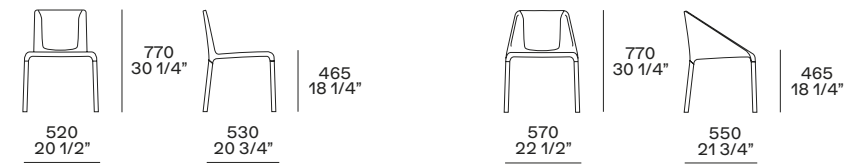

GUEST

Rodolfo Dordoni disegna una sedia capace di suggerire – col suo nome e visivamente – l'idea di ospitalità e comfort. Per le sue proporzioni ampie e le linee morbide, più simile a una poltroncina che a una sedia, Guest è ideale attorno a un tavolo e perfetta anche da sola, accanto a uno scrittoio.

Rodolfo Dordoni designs a chair capable of suggesting – with its name and visually – the idea of hospitality and comfort. Because of its large proportions and soft lines, more similar to an armchair than a chair, Guest is ideal around a table and perfect even by itself, next to a writing desk.



Qui e nella pagina precedente: sedia Guest con rivestimento non sfoderabile in pelle Soft 10 prugna, cuscino seduta sfoderabile nella stessa finitura. Scrivitoio Mathieu con struttura brown nickel lucido e piano con cornice rovere spessart e inserto in cuoio 29 tortora. Cassetto sottopiano in laccato carbone e specchio con struttura brown nickel lucido. Nella pagina successiva: sedia Guest con rivestimento non sfoderabile in velluto Persia 2012 visone, cuscino seduta sfoderabile nella stessa finitura.

This and previous page: Guest chair with non-removable cover in leather Soft 10 prugna, seat cushion with removable cover in the same material. Mathieu writing desk with glossy brown nickel structure and tabletop with frame in spessart oak, insert in hide 29 tortora. Undermount drawer lacquered carbone and mirror with glossy brown nickel structure. Next page: Guest chair with non-removable cover in velvet Persia 2012 visone, seat cushion with removable cover in the same material.





GUEST

Design Rodolfo Dordoni, 2014

Scocca in poliuretano flessibile stampato con telaio in metallo, prriverestimento in fibra di poliestere. Rivestimento non sfoderabile in tessuto o pelle. Cuscino seduta con rivestimento sfoderabile in tessuto o pelle. Ruote a scomparsa.

Body in flexible moulded polyurethane with metal frame, pre-cover in polyester fibre. Non-removable cover in fabric or leather. Seat cushion with removable cover in fabric or leather. Invisible wheels.

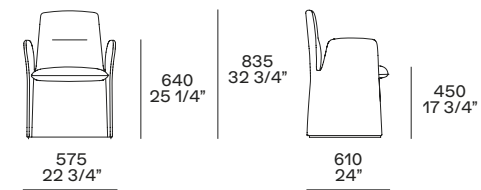

BB

Blumer e Borghi siglano con le loro iniziali un progetto dal design evoluto. BB è un esoscheletro in cuoio iniettato con un leggerissimo poliuretano espanso che conferisce forma e comfort alla sedia. Un lavoro incentrato sull'efficienza dei materiali, per una nuova perfezione estetica.

Blumer and Borghi sign with their initials a project of advanced design. BB is an exoskeleton in leather injected with a very light polyurethane foam that gives shape and comfort to the chair. A work focused on the efficiency of materials, for a new aesthetic perfection.



Nella pagina precedente: sedia BB completamente rivestita in cuoio non sfoderabile 02 nero. Qui e nella pagina successiva: sedia BB completamente rivestita in cuoio non sfoderabile 26 invecchiato.

Previous page: BB chair fully covered in non-removable hide 02 nero. This and next page: BB chair fully covered in non-removable hide 26 invecchiato.





BB

Design Blumer e Borghi, 2008

Struttura in poliuretano rigido a bassa densità, completamente rivestita e non sfoderabile in cuoio co-stampato nei colori 02 nero, 03 grigio scuro, 19 caffè o 26 invecchiato.

Structure in rigid polyurethane in low density, fully covered in non-removable hide in the colours 02 nero, 03 grigio scuro, 19 caffè or 26 invecchiato.

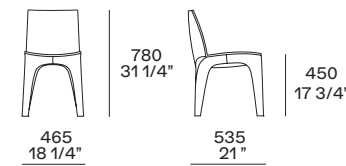

BENCHES

Versatili e attuali, le panche possono completare un sistema di sedute o vivere autonomamente nei contesti più informali. Emmanuel Gallina immagina la panca come un pouf: imbottita e rivestita in tessuto, Jane è una confortevole seduta aggiuntiva per la zona giorno, ideale anche accanto a un tavolo. Jean-Marie Massaud predilige invece le linee essenziali e il calore del legno, e con Home Hotel trasforma la classica panca in un elemento di grande eleganza per tutti gli ambienti della casa.

Versatile and modern, benches can complete a seating system or live independently in more informal settings. Emmanuel Gallina imagines the bench as a pouf: padded and upholstered in fabric, Jane is a comfortable additional seat for the day area, also ideal next to a table. Jean-Marie Massaud instead favours minimalistic lines and the warmth of wood, and with Home Hotel transforms the classic bench into an element of great elegance for all the environments of the house.

BENCHES

JANE

145

HOME HOTEL

153

JANE

Disegnata da Emmanuel Gallina, Jane è una collezione di elementi imbottiti dalle dimensioni contenute. Elegante ed essenziale, la panca ha una seduta imbottita e una struttura sottile e dinamica con piedi in metallo oppure in essenza, che la rendono perfetta accanto a un tavolo così come negli ambienti di passaggio.

Designed by Emmanuel Gallina, Jane is a collection of padded elements of small dimensions. Elegant and minimalistic, the bench has a padded seat and a slim and dynamic structure with metal or wood feet, which make it perfect next to a table as well as in transit areas.



Nella pagina precedente: panca Jane rivestimento sfoderabile in tessuto Orleans 12 carbone, struttura brown nickel lucido. Sedie Sophie senza braccioli, rivestimento non sfoderabile in pelle Soft 14 oliva, struttura in olmo nero. Tavolo Concorde con struttura e cornice piano in olmo nero, piano in vetro lucido bordeaux. In questa pagina: panca Jane rivestimento sfoderabile in tessuto Naxos 21 roccia, struttura in olmo nero. Nella successiva: panca Jane rivestimento non sfoderabile in pelle Nabuk 06 mastice, struttura brown nickel lucido.

Previous page: Jane bench covered in removable fabric Orleans 12 carbone, glossy brown nickel structure. Sophie chairs without armrests, cover in non-removable leather Soft 14 oliva, and structure in black elm. Concorde table with structure and top frame in black elm, tabletop in glossy glass Bordeaux. This page: Jane bench covered in removable fabric Naxos 21 roccia, black elm structure. Next page: Jane bench with non-removable cover in leather Nabuk 06 mastice, glossy brown nickel structure.





JANE

Design Emmanuel Gallina, 2017

Seduta in poliuretano flessibile a quote differenziate, priverivestimento in fibra di poliestere. Rivestimento in tessuto sfoderabile o in pelle non sfoderabile. Struttura in massello, finitura rovere spessart o olmo nero. Struttura in metallo verniciato brown nickel opaco o lucido.

Seat in flexible polyurethane in different densities, pre-cover in polyester fibre. Cover in removable fabric or in non-removable leather. Structure in solid, wood spessart oak or black elm finish. Structure in metal or glossy brown nickel painted metal.

Panca struttura in essenza Bench with structure in wood

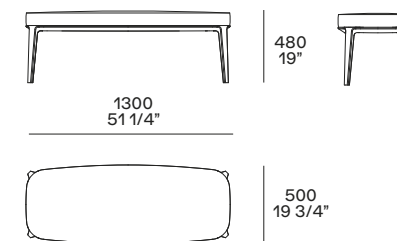

Poggiapiedi struttura in essenza Footrest with structure in wood

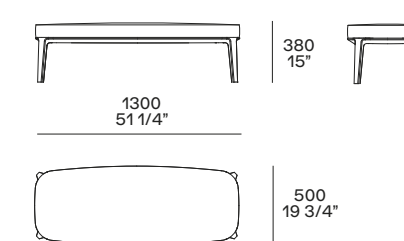

Panca struttura in metallo Bench with structure in metal

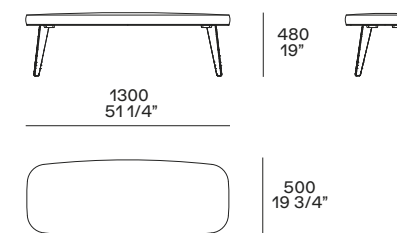

Poggiapiedi struttura in metallo Footrest with structure in metal

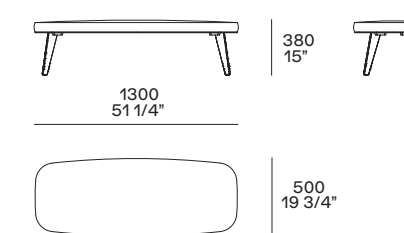



HOME HOTEL

La collezione Home Hotel, disegnata da Jean-Marie Massaud, si compone di una serie di elementi dall'eleganza discreta, liberamente combinabili tra loro. Il nome stesso ne suggerisce la grande versatilità, che spazia dall'ambiente domestico ai luoghi dell'ospitalità. La panca è disponibile in diverse altezze e dimensioni, anche con seduta rivestita in cordatura di pelle.

The Home Hotel collection, designed by Jean-Marie Massaud, consists of a series of discrete elegance elements, freely combinable with each other. The name itself suggests its great versatility, ranging from the domestic environment to hospitality venues. The bench is available in different heights and sizes, even with a stringed leather seat.



Nella pagina precedente e nella successiva: panca Home Hotel struttura in olmo nero e seduta rivestita in cordatura di pelle testa di moro. In questa pagina: panca Home Hotel struttura e seduta a listelli in olmo nero. Cuscino con rivestimento sfoderabile in pelle Nabuk 01 latte e parte superiore in pelle Nabuk intrecciata 01 latte.

Previous and next page: Home Hotel bench structure in black elm and seat covered in dark brown stringed leather. This page: Home Hotel bench with structure and seat in black elm with slats. Cushion with removable cover in leather Nabuk 01 latte and upper side in woven leather Nabuk 01 latte.





HOME HOTEL

Design Jean-Marie Massaud, 2016

Struttura in massello, finitura olmo nero. Seduta panche h 440 mm e poggiatesta in olmo nero rivestita in cordatura di pelle testa di moro. Seduta panche h 340 mm in olmo nero o in massello finitura olmo nero nella versione a listelli. Cuscino opzionale con rivestimento sfoderabile in tessuto o pelle; nella versione pelle Nabuk possibilità pelle Nabuk intrecciata nella parte superiore.

Structure in solid wood, black elm finish. Benches seat h 440 mm and footrest in black elm, covered with dark brown stringed leather. Benches seat h 340 in black elm or solid wood black elm finish for the version with slats. Optional cushion with removable cover in fabric or leather. In the version in leather Nabuk, the upper part can be in woven leather.

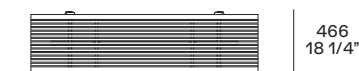
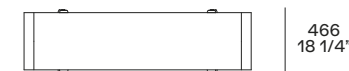
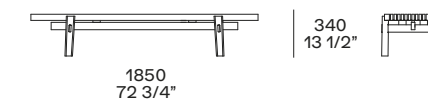
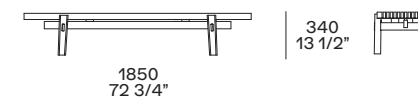
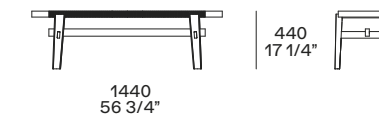
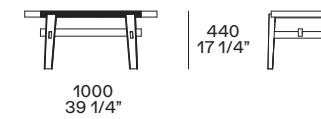

Poggiatesta Footrest

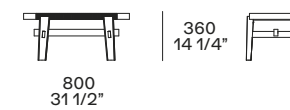

Cuscino Cushion

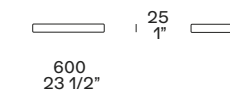

STOOLS

Un tempo riservati ai luoghi della convivialità, gli sgabelli sono diventati un complemento indispensabile accanto ai piani snack delle cucine contemporanee. Proprio in questa direzione vanno i progetti di Emmanuel Gallina, Jean-Marie Massaud e Rodrigo Torres, che ridisegnano le sedie Sophie, Ventura e Harmony lavorando sulle proporzioni e sul comfort della seduta, reso più complesso dalla verticalità. Dei modelli originari gli sgabelli mantengono il nome, così come le forme avvolgenti e la cura per i materiali e le lavorazioni. Completano la collezione Ics e Ipsilon, sgabelli-tavolini in essenza, poliedrici e versatili.

Once reserved for places of conviviality, stools have become an indispensable complement next to the snack tops of contemporary kitchens. The projects of Emmanuel Gallina, Jean-Marie Massaud, and Rodrigo Torres go in this direction, redesigning the chairs Sophie, Ventura, and Harmony, working on the proportions and comfort of the seat, made more complex by the verticality. Of the original models the stools keep the name, as well as the enveloping shapes and attention for the materials and details. Ics and Ipsilon complete the collection, stools-coffee tables in wood, polyhedral and versatile.

STOOLS

SOPHIE	165
VENTURA	175
HARMONY	185
ICS - IPSILON	195

SOPHIE

L'eleganza classica della sedia Sophie riletta in forma di sgabello. Nel progetto più recente di Emmanuel Gallina restano immutati il disegno delicato del bracciolo e la seduta generosa, mentre la struttura in massello si arricchisce del poggiatesta, dettaglio funzionale e di stile.

The classic elegance of the Sophie chair reinterpreted in the shape of a stool. In the most recent project by Emmanuel Gallina, the delicate design of the armrest and the generous seat remain unchanged, while the solid wood structure is enriched with a footrest, a functional and stylistic detail.



Nella pagina precedente: sgabelli Sophie con rivestimento non sfoderabile in pelle Soft 03 nocciola, struttura in olmo nero e poggiatesta in brown nickel opaco con inserto inox satinato. Cucina Shape, design R&D Poliform in laccato lucido tortora, cappa Infinity in acciaio scotch brite e vetro extralight. Piano snack Moon in massello rovere di palude con piano girevole integrato in marmo lucido emperador extra dark. In questa pagina: sgabello Sophie con rivestimento non sfoderabile in tessuto Naxos 32 bordeaux, struttura in olmo nero e poggiatesta in brown nickel opaco con inserto inox satinato.

Previous page: Sophie stools with non-removable cover in leather Soft 03 nocciola, structure in black elm and footrest in mat brown nickel with inlay in brushed stainless steel. Kitchen Shape, design R&D Poliform, in tortora glossy lacquer, hood Infinity in steel scotch brite and extralight glass. Snack top Moon in solid bog oak with integrated swivel tray in glossy marble emperador extra dark. This page: Sophie stool with non-removable cover in fabric Naxos 32 bordeaux, structure in black elm and footrest in mat brown nickel with inlay in brushed stainless steel.





In questa pagina: sgabello Sophie con rivestimento non sfoderabile in pelle Soft 08 visone, struttura in olmo nero e poggiatesta in brown nickel opaco con inserto inox satinato. Nella pagina successiva: cucina Shape, design R&D Poliform. Basi e colonne in laccato lucido tortora, cappa Infinity in acciaio scotch brite e vetro extralight. Piano snack Moon in massello rovere di palude con sgabelli Sophie con rivestimento non sfoderabile in pelle Soft 03 nocciola, struttura in olmo nero e poggiatesta in brown nickel opaco con inserto inox satinato.

This page: Sophie stool with non-removable cover in leather Soft 08 visone, structure in black elm and footrest in mat brown nickel with inlay in brushed stainless steel. Next page: kitchen Shape, design R&D Poliform. Base units and tall units in tortora glossy lacquer, hood Infinity in steel scotch brite and extralight glass. Snack top Moon in solid bog oak, stools Sophie with non-removable cover in leather Soft 03 nocciola, structure in black elm and footrest in mat brown nickel with brushed stainless steel inlay.





SOPHIE

Design Emmanuel Gallina, 2018

Seduta e schienale con parti in poliuretano flessibile a quote differenziate e parti in poliuretano flessibile stampato, prriverstimento in fibra di poliestere. Rivestimento non sfoderabile in tessuto o pelle. Struttura in massello, finitura rovere spessart o olmo nero. Poggiapiedi in metallo verniciato brown nickel opaco con inserto inox satinato.

Seat and back with parts in flexible polyurethane in different densities and parts in moulded flexible polyurethane, pre-cover in polyester fibre. Non-removable cover in fabric or leather. Structure in solid wood, finish spessart oak or black elm. Footrest in mat brown nickel painted metal with inlay in brushed stainless steel.

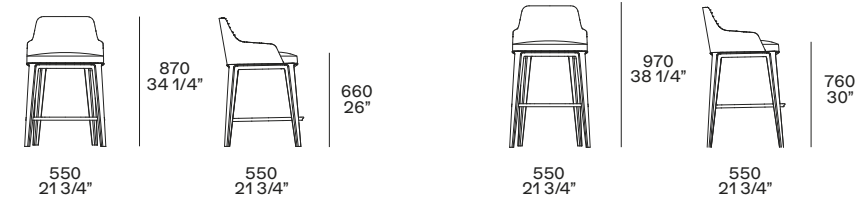



VENTURA

Dell'omonima collezione di sedute, lo sgabello riprende la caratteristica struttura. Pensato per completare le cucine più attuali, Ventura riesce a coniugare contemporaneità e comfort grazie allo schienale e all'imbottitura, da rivestire a piacere in tessuto o pelle.

From the homonymous collection of seats, the stool borrows the characteristic structure. Designed to complete the most modern kitchens, Ventura manages to combine modernity and comfort thanks to the backrest and the padding, to be upholstered in fabric or leather.



Nella pagina precedente: sgabello Ventura con rivestimento non sfoderabile in pelle Soft 04 cognac, struttura in olmo nero e poggiatesta in acciaio inox. Cucina Phoenix, design R&D Poliform. Basi in acciaio con piano snack Blade in olmo nero. In questa pagina: sgabello Ventura con rivestimento non sfoderabile in pelle Soft 09 bulgaro, cucitura normale doppia, struttura in rovere spessart e poggiatesta in acciaio inox.

Previous page: Ventura stool with non-removable cover in leather Soft 04 cognac, black elm structure and footrest in stainless steel. Phoenix kitchen, design R&D Poliform. Base units in steel with Blade snack top in black elm. This page: Ventura stool with non-removable cover in leather Soft 09 bulgaro, normal double stitching, structure in spessart oak and footrest in stainless steel.





In questa pagina: sgabello Ventura con rivestimento non sfoderabile in tessuto Zante 10 nero, cucitura a cordoncino in tinta, struttura in olmo nero e poggiatesta in acciaio inox. Nella pagina successiva: sgabello Ventura con rivestimento non sfoderabile in pelle Soft 04 cognac, struttura in olmo nero e poggiatesta in acciaio inox. Cucina Phoenix, design R&D Poliform. Basi in acciaio con piano snack Blade in olmo nero. Cappa Factory in acciaio. Colonne con ante in olmo nero.

This page: Ventura stool with non-removable cover in fabric Zante 10 nero, drawstring stitching in matching colour, structure in black elm and footrest in stainless steel. Next page: Ventura stool with non-removable cover in leather Soft 04 cognac, structure in black elm and footrest in stainless steel. Phoenix kitchen, design R&D Poliform. Base units in steel with Blade snack top in black elm. Factory hood in steel. Tall units with doors in black elm.

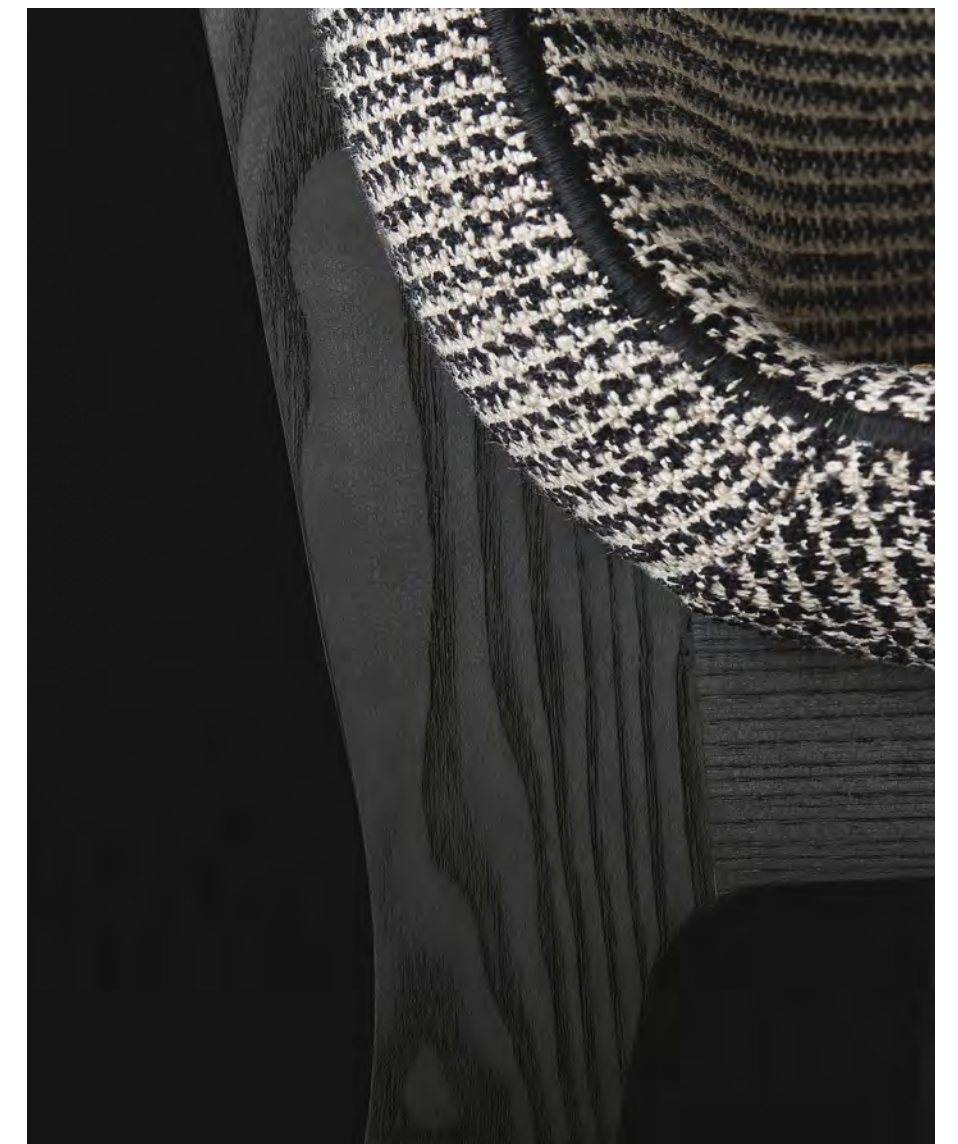



VENTURA

Design Jean-Marie Massaud, 2016

Scocca in poliuretano flessibile stampato, prriverestimento in fibra di poliestere. Rivestimento non sfoderabile in tessuto o pelle. Cucitura normale doppia o solo per la versione in tessuto (escluso velluto) cucitura a cordoncino in tinta. Struttura in massello, finitura rovere spessart o olmo nero. Poggiapiedi in acciaio inox.

Body in moulded flexible polyurethane, pre-cover in polyester fibre. Non-removable cover in fabric or leather. Normal double stitching or drawstring stitching in matching colour only for the fabric version (except velvet). Structure in solid wood, spessart oak or black elm finish. Footrest in stainless steel.

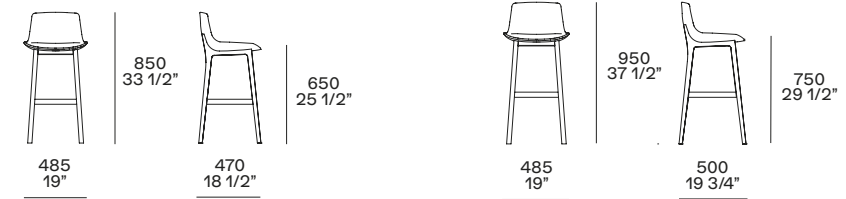

HARMONY

Evoluzione dell'omonima sedia, Harmony ne reinterpreta il concept come sgabello. In questo formato, con la seduta di dimensioni ridotte e la struttura leggera e slanciata, acquista ancora più espressività, portando un design attuale e innovativo anche in cucina.

Evolution of the homonymous chair, Harmony reinterprets its concept as a stool. In this format, with the small-sized seat and the light and slender structure, it acquires even more expressiveness, bringing a current and innovative design even in the kitchen.



Qui e nella pagina precedente: sgabello Harmony con seduta in rovere spessart e struttura in cromo nero. Cucina Twelve, design Carlo Colombo e R&D Poliform. Basi in vetro satinato bianco extrachiaro e sagoma in laccato goffrato carbone. Piano snack Sydney in massello tinto olmo nero.

This and previous page: Harmony stool with seat in spessart oak and black chrome structure. Twelve kitchen, design Carlo Colombo and R&D Poliform. Base units in frosted glass extralight bianco and carbone embossed lacquered handle profile. Snack top Sydney in solid wood stained black elm.





Qui e nella pagina successiva: sgabelli Harmony con seduta in rovere spessart e struttura in cromo nero. Cucina Twelve, design Carlo Colombo e R&D Poliform. Basi in vetro satinato bianco extrachiaro e sagoma in laccato goffrato carbone; top e fianchi in Dekton bianco. Piano snack Sydney in massello tinto olmo nero. Cappa Work in acciaio e vetro. Colonne in laccato metallico bronzo e in vetro fumé.

This and next page: Harmony stool with seat in spessart oak and black chrome structure. Twelve kitchen, design Carlo Colombo and R&D Poliform. Base units in frosted glass extralight bianco and carbone embossed lacquered handle profile; worktop and sides in Dekton bianco. Snack top Sydney in solid wood stained black elm. Work hood in steel and glass. Tall units in metal lacquer bronzo and fumé glass.

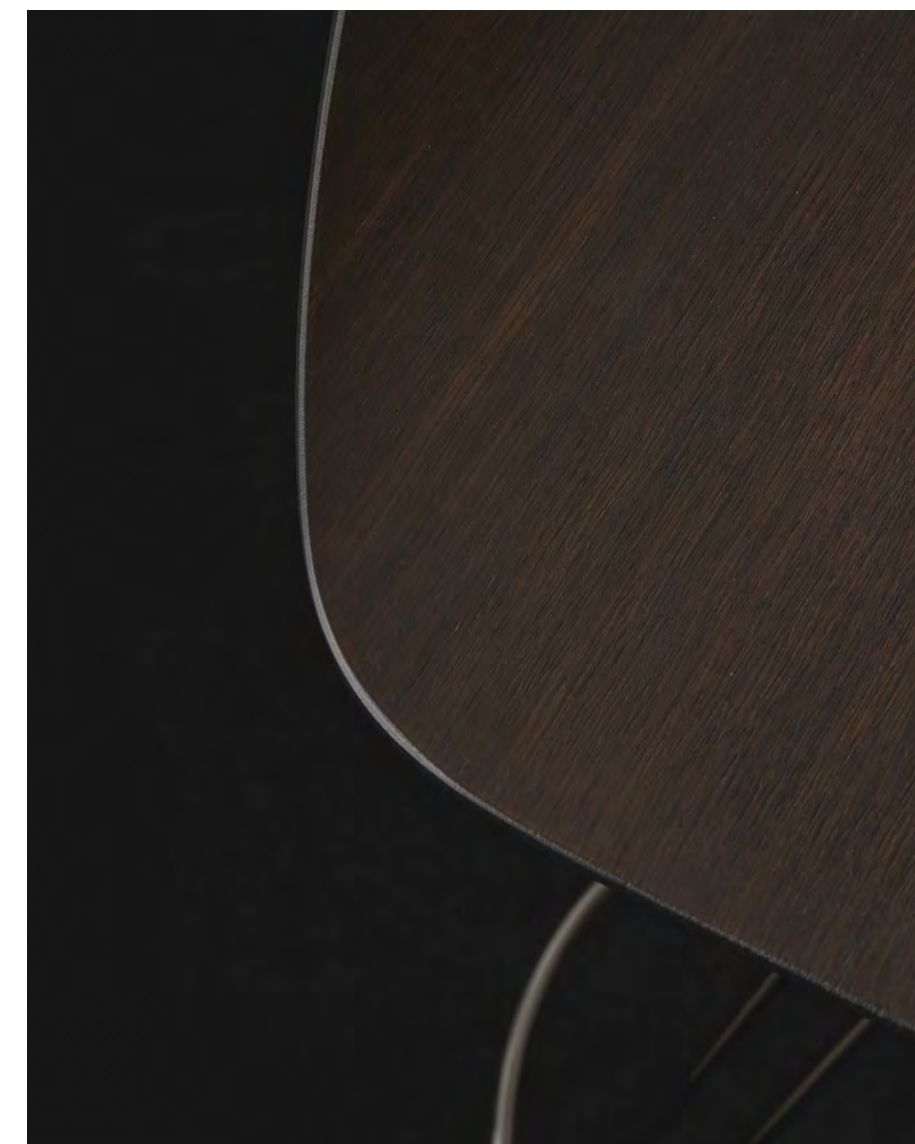



HARMONY

Design Rodrigo Torres, 2012

Scocca in legno curvato con tecnica 3D, finitura rovere spessart. Struttura in tondino di metallo finitura cromo nero.

Body in curved wood with 3D technology, spessart oak finish. Structure in metal rod black chrome finish.

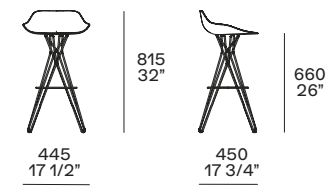



ICS IPSILO

Perfetto connubio tra essenzialità e solidità, Ics e Ipsilon si basano sulle forme geometriche del triangolo e del quadrato, rese più gentili dagli angoli smussati. A sostenere il sedile, tre e quattro gambe inclinate e solide.

Perfect combination of minimalism and solidity, Ics and Ipsilon are based on the geometric shapes of the triangle and the square, made softer by the rounded corners. To support the seat, three or four inclined and solid legs.



Qui e nella pagina precedente: sgabelli Ics con seduta e struttura in rovere spessart, poggiatesta in acciaio inox. Cucina Alea, design R&D Poliform. Basi isola in laccato gofrato ghiaccio con piano snack in pietra stone brown levigata. Colonne in rovere spessart.

This and previous page: Ics stools with seat and structure in spessart oak, footrest in stainless steel. Alea kitchen, design R&D Poliform. Island base units ghiaccio embossed lacquered with snack top in stone brown mat finishing. Tall units in spessart oak.





In questa pagina: sgabello Ipsilon con seduta e struttura in rovere spessart. Nella pagina successiva: sgabelli Ics con seduta e struttura in rovere spessart, poggiatesta in acciaio inox. Cucina Alea, design R&D Poliform. Basi isola in laccato goffrato ghiaccio con piano snack in pietra stone brown levigata e top in DuPont Corian® pearl gray. Colonne in rovere spessart. Basi con ante ed estrattori in rovere spessart, top e schienali in pietra stone brown levigata. Cappa Flat verniciata nera a isola personalizzata Poliform.

This page: Ipsilon stool with seat and structure in spessart oak. Next page: Ics stools with seat and structure in spessart oak, footrest in stainless steel. Alea kitchen, design R&D Poliform. Island base units ghiaccio embossed lacquered with snack top in stone brown mat finishing and worktop in DuPont Corian® pearl gray. Tall units in spessart oak. Base units with doors and pullout baskets in spessart oak, worktop and backs in stone brown mat finishing. Black painted Flat island hood, personalized Poliform.





ICS - IPSILON

Design Rodrigo Torres, 2010

Seduta in rovere spessart. Struttura in massello, finitura rovere spessart. Sgabello lcs con poggipiedi in acciaio inox.

Seat in spessart oak. Structure in solid wood, spessart oak finish. lcs stool with footrest in stainless steel.

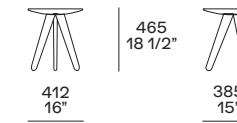
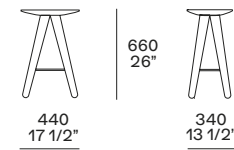

TABLES

Una collezione nel segno della continua ricerca estetica, che esplora gli stili e le ispirazioni più diverse. Con un'eccezionale varietà di materiali e finiture, dalle dimensioni più importanti o contenute, le proposte di Poliform vanno dalle più classiche – come quelle firmate da Jean-Marie Massaud, Emmanuel Gallina e Marcel Wanders – a quelle più versatili – come i tavoli disegnati da Roberto Barbieri. Elementi cardine dell'area conviviale, i tavoli si rivelano adatti a tutti gli spazi di casa.

A collection in the name of continuous aesthetic research, which explores the most diverse styles and inspirations. With an exceptional variety of materials and finishes, from big to small dimensions, Poliform's offers range from the most classic – such as those signed by Jean-Marie Massaud, Emmanuel Gallina, and Marcel Wanders – to the most versatile ones – such as the tables designed by Roberto Barbieri. Cardinal elements of the convivial area, the tables are suitable for all the environments of the house.

TABLES

KENSINGTON	209
CONCORDE	225
HOME HOTEL	241
FLUTE	257
HOWARD	267
MAD DINING TABLE	279
OPÉRA	291
GILL	303
BLADE	313
TREVI	325



KENSINGTON

Kensington è un tavolo-scultura disegnato da Jean-Marie Massaud. La struttura è caratterizzata dai moduli circolari, che sostengono un piano composto di elementi di forme e misure diverse. Rotondo o rettangolare, Kensington è un tavolo maestoso e suggestivo, un'opera d'arte per il living o l'ingresso.

Kensington is a sculpture-table designed by Jean-Marie Massaud. The structure is characterized by circular modules, which support a top composed of elements of different shapes and sizes. Round or rectangular, Kensington is a majestic and suggestive table, a work of art for the living or the hall.





Nelle pagine precedenti: tavolo Kensington struttura in spatolato bronzo e piano in olmo nero. Sedie Stanford Bridge rivestimento non sfoderabile in tessuto Kitami 04 sabbia, basamento girevole in brown nickel lucido. Madio Home Hotel in olmo nero, ante e cassetti con frontali sagomati laccato opaco caramello e bordo in olmo nero. Pouf New York rivestimento sfoderabile in tessuto Norway 08 avorio e piedini brown nickel opaco. In questa pagina: tavolo Kensington struttura spatolato ferro con piano in vetro fumé.

Previous pages: Kensington table with structure in bronzo with spatula finish and black elm top. Stanford Bridge chairs with non-removable cover in fabric Kitami 04 sabbia, glossy brown nickel swivel base. Home Hotel sideboard in black elm, doors and drawers with caramello mat lacquered shaped fronts and edge in black elm. New York pouf with removable cover in fabric Norway 08 avorio and mat brown nickel feet. This page: Kensington table structure in ferro with spatula finish with top in fumé glass.

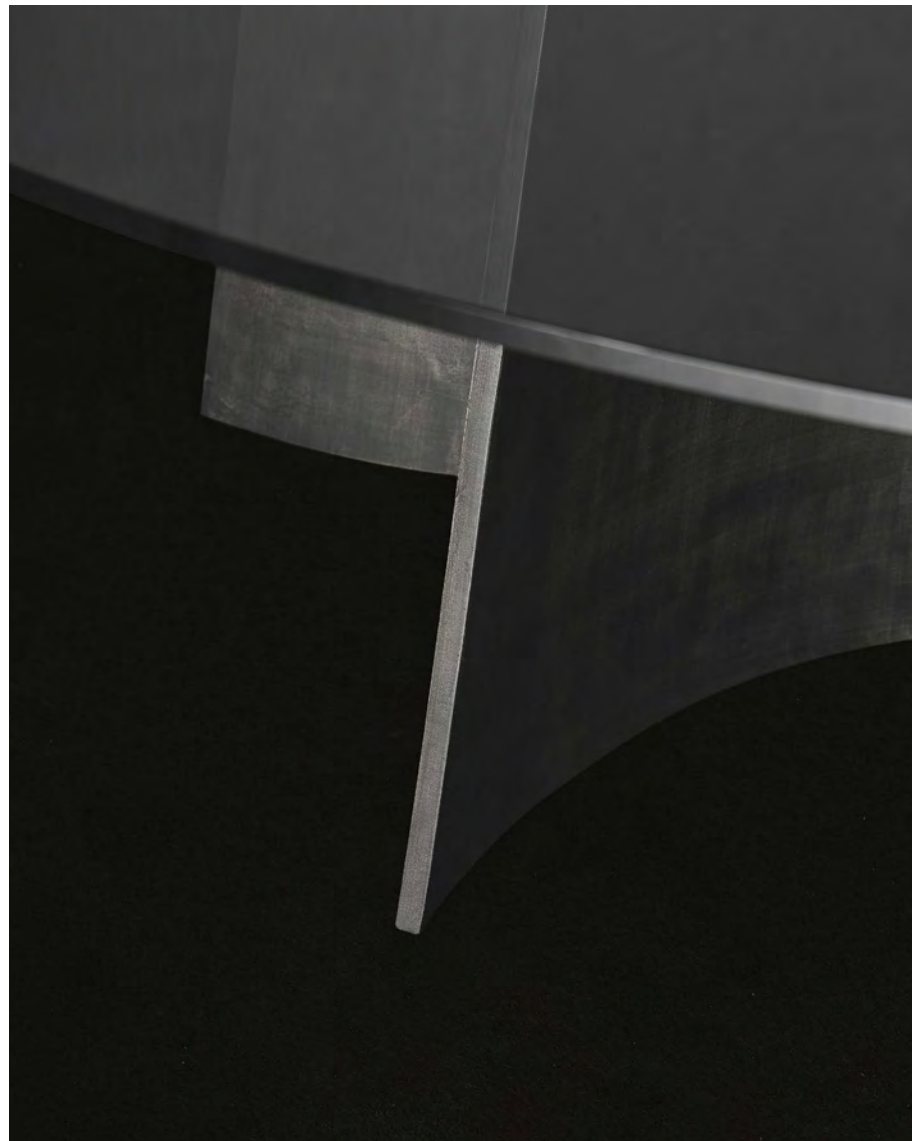



Nella pagina precedente: tavolo Kensington in metallo spatolato bronzo con piano in marmo calacatta oro lucido. In questa pagina: tavolo Kensington struttura spatolato ferro con piano in olmo nero.

Previous page: Kensington table in metal bronze with spatula finish with top in glossy marble calacatta oro. This page: Kensington table structure in ferro with spatula finish and black elm top.



In questa pagina: tavolo Kensington struttura spatolato ferro con piano in marmo lucido sahara noir finitura poliester. Sedie Seattle con seduta e gambe rivestite in cuoio non sfoderabile 02 nero. Pouf Onda in tessuto sfoderabile Sendai 03 fango. Madia Free in laccato lucido granata. Tappeto Plain tortora. Nella pagina successiva: tavolo Kensington struttura spatolato bronzo con piano in olmo nero. Tappeto Plain cipria.

This page: Kensington table structure in ferro with spatula finish with top in glossy marble sahara noir with polyester finish. Seattle chairs with seat and legs covered in non-removable hide 02 nero. Onda pouf in removable fabric Sendai 03 fango. Granata glossy lacquered Free sideboard. Carpet Plain tortora. Next page: Kensington table structure in bronzo with spatula finish and black elm top. Carpet Plain cipria.





KENSINGTON

Design Jean-Marie Massaud, 2018

Struttura in alluminio spatolato ferro e bronzo o laccato opaco champagne. Piano in olmo nero, vetro fumé, marmo lucido noir saint laurent, marmo levigato e lucido bianco carrara, grigio stardust, calacatta oro o sahara noir finitura poliestere. Il piano è caratterizzato dall'accostamento di moduli di forme e misure diverse.

Structure in aluminium with spatula finish ferro and bronzo or champagne mat lacquered. Top in black elm, fumé glass, glossy marble noir saint Laurent, mat and glossy marble bianco carrara, grigio stardust, calacatta oro or sahara noir with polyester finish. The top is distinguished by the combination of modules with different shape and size.

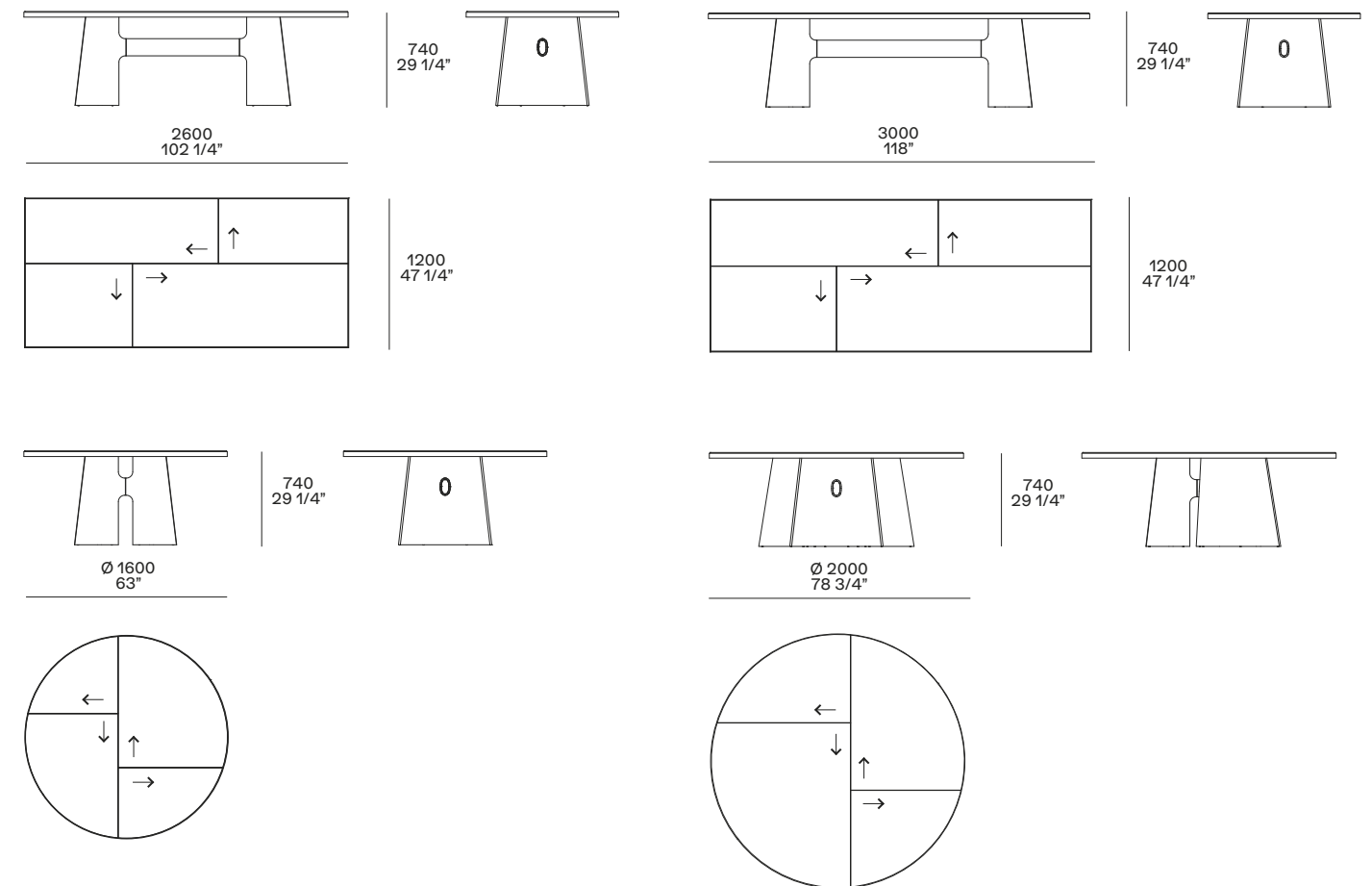

Le frecce indicano l'orientamento delle venature del legno.
The drawing shows the direction of the wooden grain.

CONCORDE



Essenziale eppure altero e importante, Concorde è un tavolo rettangolare o tondo con piano centrale girevole, più in linea con l'intimità di un soggiorno domestico. La struttura è in legno mentre il piano è disponibile in essenza, marmo o, nella versione rettangolare, anche in vetro con cornice in essenza.

Minimalistic yet proud and important, Concorde is a rectangular or round table with a revolving central top, more in line with the intimacy of a domestic living room. The structure is in wood while the top is available in wood, marble or, in the rectangular version, also in glass with a wooden frame.

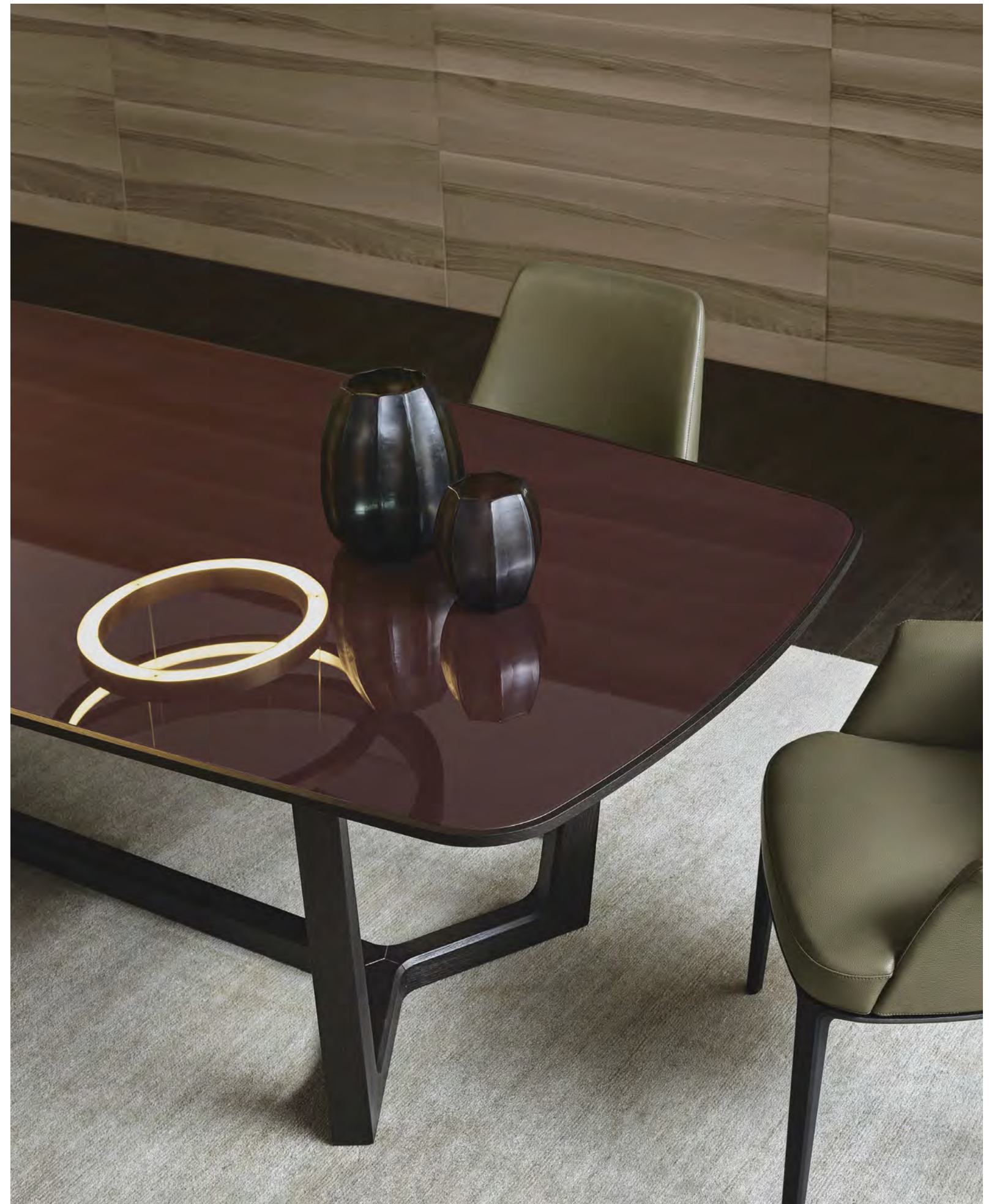



Nelle pagine precedenti: tavolo Concorde con struttura e cornice piano in olmo nero, piano in vetro lucido bordeaux. Sedie Sophie con e senza bracciolo, rivestimento non sfoderabile in pelle Soft 14 oliva, struttura in olmo nero. Panca Jane rivestimento sfoderabile in tessuto Orleans 12 carbone, struttura brown nickel lucido. In questa pagina: tavolo Concorde in olmo nero con piano in marmo grigio stardust lucido, inserti in brown nickel opaco e vassoio centrale girevole in olmo nero.

Previous pages: Concorde table with structure and top wooden frame in black elm, tabletop in glossy glass bordeaux. Sophie chairs with and without armrest, cover in non-removable leather Soft 14 oliva, and structure in black elm. Jane bench covered in removable fabric Orleans 12 carbone, structure in glossy brown nickel. This page: Concorde table in black elm with top in glossy marble grigio stardust inlays in mat brown nickel and swivel tray in black elm.







Nella pagina precedente: tavolo Concorde con struttura in olmo nero e piano in marmo calacatta oro levigato. In questa pagina: tavolo Concorde con struttura e piano in olmo nero con inserti in brown nickel opaco.

Previous page: Concorde table with structure in black elm and top in mat marble calacatta oro. This page: Concorde table with structure and top in black elm with inlays in mat brown nickel.



In questa pagina: tavolo Concorde in rovere spessart con piano in marmo calacatta oro levigato e vassoio centrale girevole in rovere spessart. Sedie Grace con braccioli, rivestimento non sfoderabile in pelle Nabuk 05 grafite, struttura in rovere spessart. Nella pagina successiva: tavolo Concorde con struttura e cornice piano in olmo nero, piano in vetro lucido bordeaux. Sedie Sophie senza braccioli, rivestimento non sfoderabile in pelle Soft 14 oliva, struttura in olmo nero. Panca Jane rivestimento sfoderabile in tessuto Orleans 12 carbone, struttura brown nickel lucido.

This page: Concorde table in spessart oak with top in mat marble calacatta oro, swivel tray in spessart oak. Grace chairs with armrests cover in non-removable leather Nabuk 05 grafite, structure in spessart oak. Next page: Concorde table with structure and top wooden frame in black elm, tabletop in glossy glass bordeaux. Sophie chairs without armrests, non-removable cover in leather Soft 14 oliva, structure in black elm. Jane bench covered in removable fabric Orleans 12 carbone, structure in glossy brown nickel.





CONCORDE

Design Emmanuel Gallina, 2009

Struttura in massello, finitura in noce c., rovere spessart, rovere cenere o olmo nero. Piano in noce c., rovere cenere, rovere spessart, olmo nero, cinque marmi levigati e sei lucidi. Per le versioni rettangolari è disponibile anche il piano in vetro lucido colori o in vetro riflettente blu con cornice in essenza. Per i tavoli Ø 1800 e 2000 mm è previsto un piano girevole opzionale in appoggio in laccato opaco colori, laccato lucido colori, noce c., rovere spessart, rovere cenere, olmo nero, cinque marmi levigati e sei lucidi.

Structure in solid wood finish in walnut c., spessart oak, cenere oak or black elm. Top in walnut c., cenere oak, spessart oak, black elm, five mat and six glossy marble finishes. For the rectangular versions, the tabletop is available also in glossy glass or in blue reflecting glass with wooden frame. For the tables Ø 1800 and 2000 mm an optional swivel tray leant on the tabletop in the following finishes is available: mat lacquered colours, glossy lacquered colours, walnut c., spessart oak, cenere oak, black elm, five mat and six glossy marble finishes.

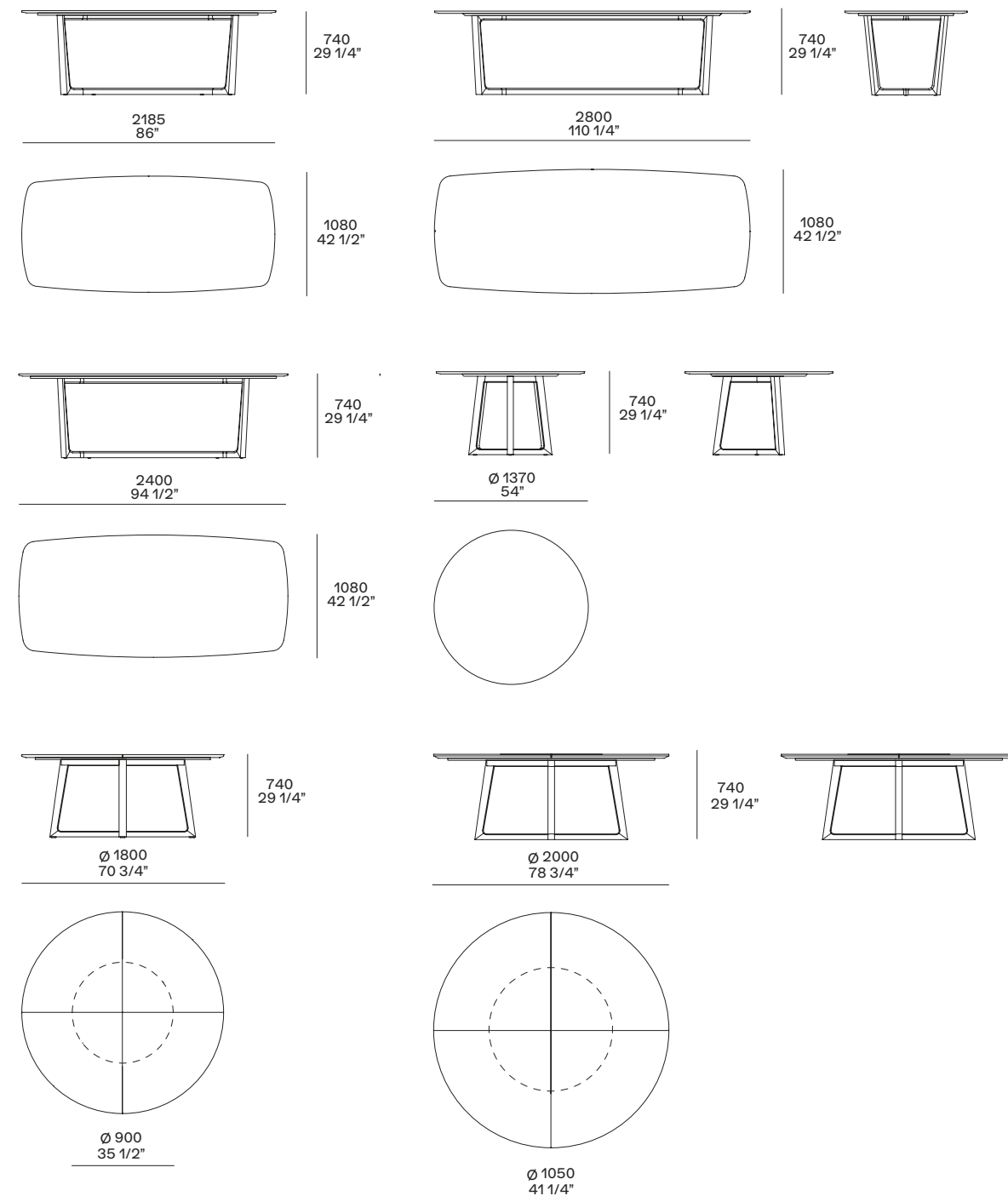

HOME HOTEL

Protagonista della collezione progettata da Jean-Marie Massaud, il tavolo Home Hotel è caratterizzato dal particolare disegno della base e dalla scelta accurata delle finiture. Realizzato in olmo nero, un'essenza di austera eleganza, nella variante rotonda è impreziosito con il piano centrale girevole in marmo.

Protagonist of the collection designed by Jean-Marie Massaud, the Home Hotel table is characterized by the particular design of the base and the careful selection of the finishes. Made of black elm, wood of austere elegance, in the round variant it is embellished with a central revolving marble top.





Nelle pagine precedenti: tavolo Home Hotel con struttura e piano in olmo nero. Sedie Seattle con braccioli, seduta e gambe rivestite in cuoio non sfoderabile 29 tortora. Tappeto Frame perla. In questa pagina: tavolo Home Hotel in olmo nero con piano centrale girevole integrato in marmo noir saint laurent lucido. Nella pagina successiva: tavolo Home Hotel con struttura e piano in olmo nero.

Previous pages: Home Hotel table with structure and top in black elm. Seattle chairs with armrests, seat and legs covered in non-removable hide 29 tortora. Carpet Frame perla. This page: Home Hotel table in black elm with integrated swivel top in glossy marble noir saint laurent. Next page: Home Hotel table with structure and top in black elm.







In questa pagina: tavolo Home Hotel con struttura e piano in olmo nero. Nella pagina successiva: tavolo Home Hotel in olmo nero con piano centrale girevole integrato in marmo noir saint laurent lucido. Sedie Ipanema con braccioli, rivestimento non sfoderabile in pelle Soft 4 cognac, struttura in olmo nero. Tappeto Plain tortora.

This page: Home Hotel table with structure and top in black elm. Next page: Home Hotel table in black elm with integrated swivel top in glossy marble noir saint Laurent. Ipanema chair with armrests, non-removable cover in leather Soft 4 cognac, structure in black elm. Carpet Plain tortora.







HOME HOTEL

Design Jean-Marie Massaud, 2016

Struttura in massello, finitura in olmo nero.
Piano in olmo nero. I tavoli ø 1800 e 2000
mm hanno un piano girevole integrato in
olmo nero, cinque marmi levigati e sei lucidi.

Structure in solid wood, black elm finish.
Top in black elm. Tables ø 1800 and 2000
mm have an integrated swivel top in black
elm, five mat and six glossy marble finishes.

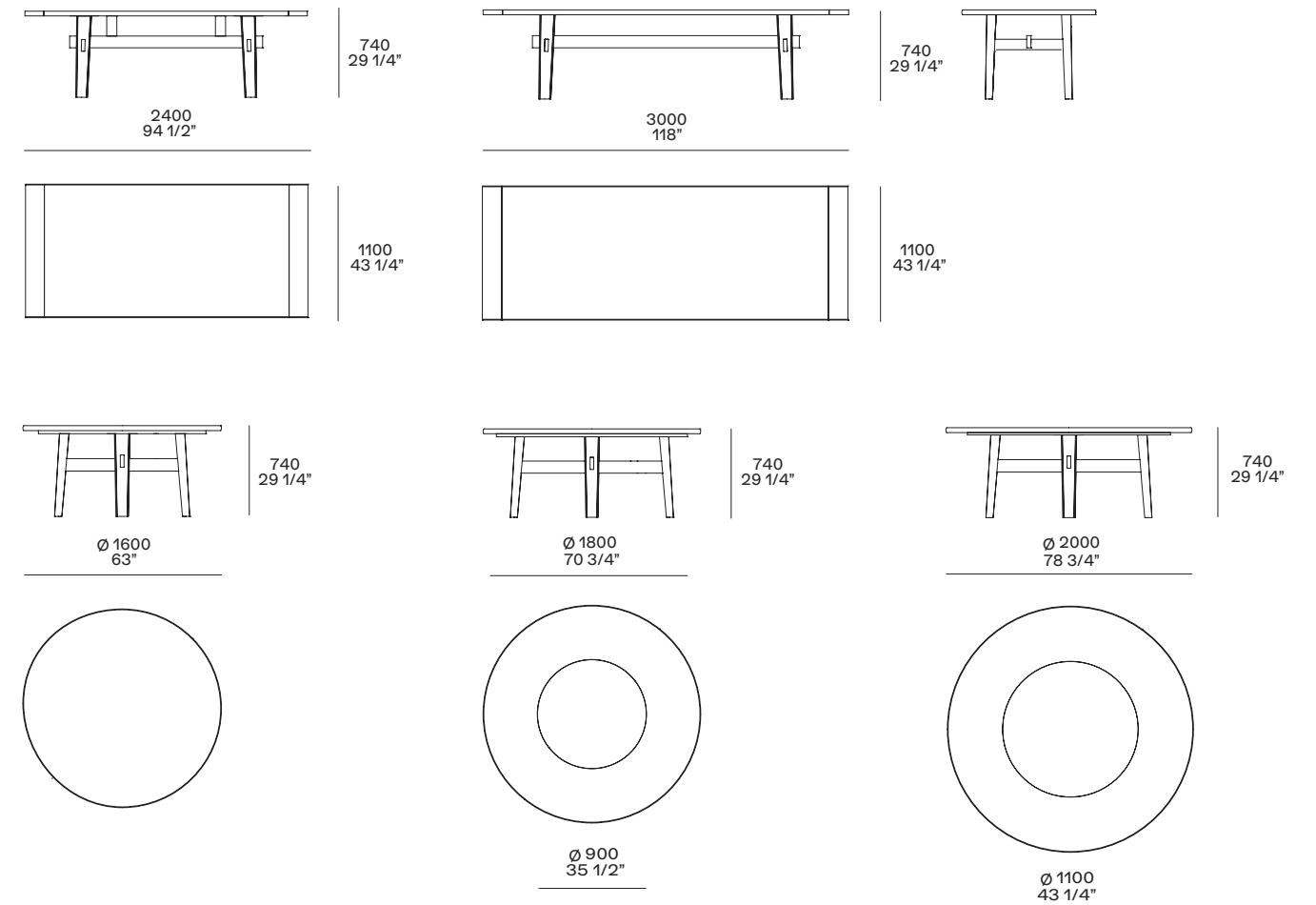



FLUTE

Un tavolo dalle dimensioni contenute per le occasioni più intime. Roberto Barbieri reinterpreta una forma classica del design con personalità, unendo alla base sottile e pulita come quella di un calice il piano rotondo, da personalizzare con tutte le finiture disponibili, dai laccati opachi e lucidi al marmo.

A small table for the most intimate occasions. Roberto Barbieri reinterprets a classic shape of design with personality, combining the thin and clean base like that of a stem glass, with a round top, to be customized with all available finishes, from mat and glossy lacquers to marble.



Nella pagina precedente: tavolo Flute laccato opaco carbone con piano in marmo lucido sahara noir finitura poliester. Sedia Stanford Bridge senza braccioli, rivestimento non sfoderabile in pelle Soft 03 nocciola, basamento girevole in brown nickel opaco. Pouf Onda in velluto sfoderabile Persia 1401 oliva. Tappeto Plain tortora. In questa pagina: tavolo Flute con struttura e piano in laccato lucido granata.

Previous page: carbone mat lacquered Flute table with top in glossy marble sahara noir with polyester finish. Stanford Bridge chair without armrests, non-removable cover in leather Soft 03 nocciola, swivel base in mat brown nickel. Onda pouf in removable velvet Persia 1401 oliva. Carpet Plain tortora. This page: Flute table with granata glossy lacquered structure and top.

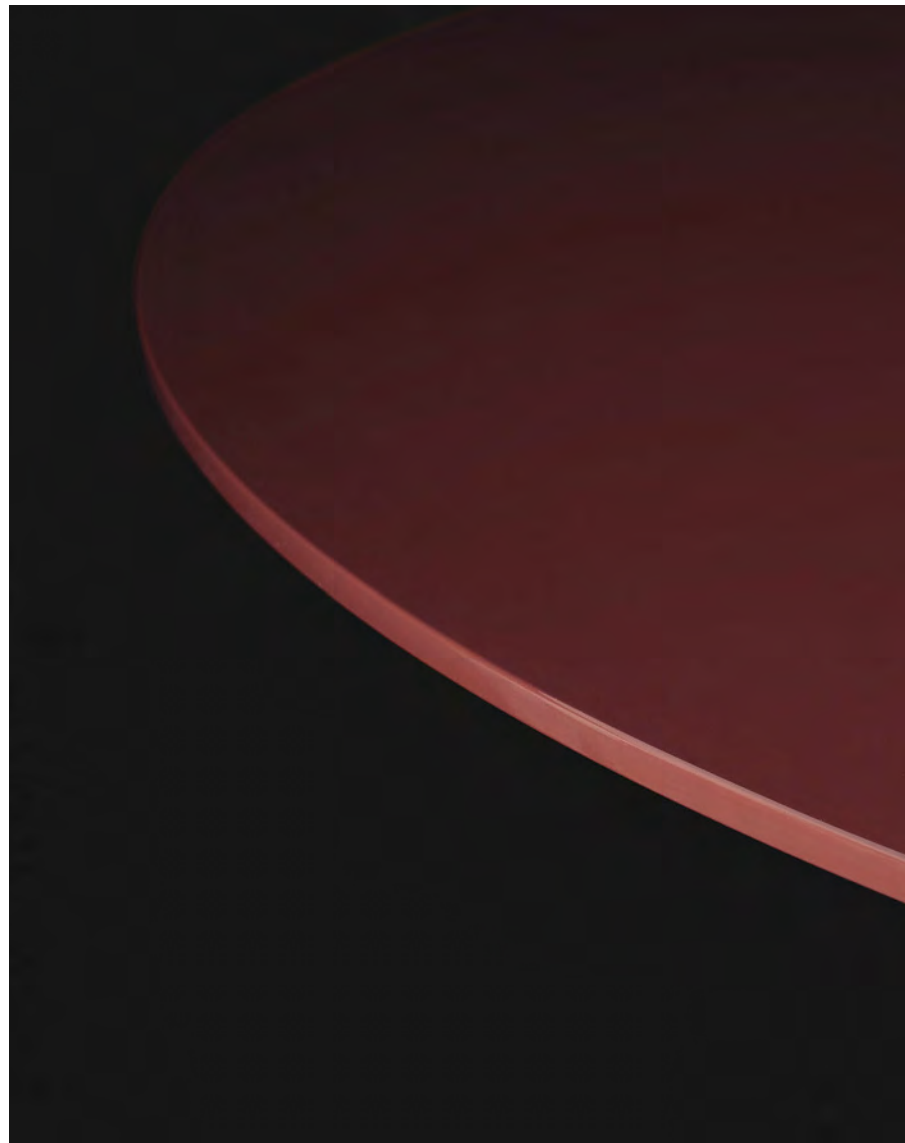



In questa pagina: tavolo Flute laccato opaco canapa con piano in marmo calacatta oro levigato. Nella pagina successiva: tavolo Flute laccato opaco carbone con piano in marmo lucido sahara noir finitura poliesteri. Sedia Stanford Bridge senza braccioli, rivestimento non sfoderabile in pelle Soft 03 nocciola, basamento girevole in brown nickel opaco. Pouf Onda in velluto sfoderabile Persia 1401 oliva. Tappeto Plain tortora.

This page: canapa mat lacquered Flute table with top in mat marble calacatta oro. Next page: carbone mat lacquered Flute table with top in glossy marble sahara noir with polyester finish. Stanford Bridge chair without armrests, non-removable cover in leather Soft 03 nocciola, swivel base in mat brown nickel. Onda pouf in removable velvet Persia 1401 oliva. Carpet Plain tortora.





FLUTE

Design Roberto Barbieri, 2008

Struttura in trafilato alluminio laccato opaco colori, laccato lucido colori, laccato antigraffio nei colori bianco 01, carbone 91, grafite 04, canapa 35 o verniciato brown nickel opaco e lucido. Piano in laccato opaco colori, laccato lucido colori, laccato antigraffio nei colori bianco 01, carbone 91, grafite 04, canapa 35, cinque marmi levigati e sei lucidi.

Structure in extruded aluminium in the finishes mat lacquered colours, glossy lacquered colours, anti-scratch lacquer in the colours bianco 01, carbone 91, grafite 04, canapa 35 or brown nickel mat and glossy. Top in the finishes mat lacquered colours, glossy lacquered colours, anti-scratch lacquer in the colours bianco 01, carbone 91, grafite 04, canapa 35, five mat and six glossy marble finishes.

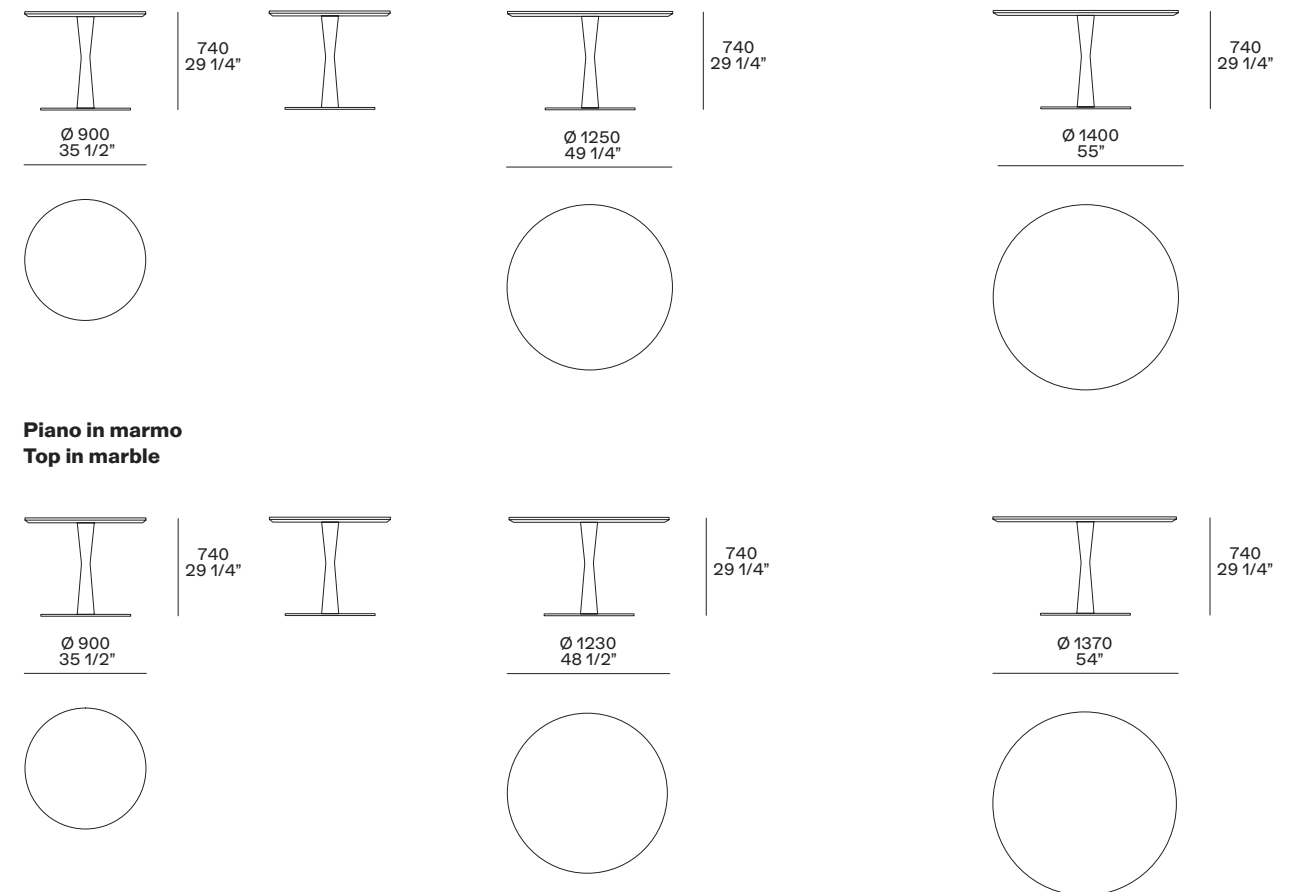



HOWARD

Disegnato da Jean-Marie Massaud, Howard è un tavolo dallo stile essenziale. La struttura autoportante in metallo tagliato a laser e legno può sostenere un elegante piano in marmo o in essenza, più caldo e naturale.

Designed by Jean-Marie Massaud, Howard is a table with a minimalistic style. The self-supporting structure in laser-cut metal and wood can support an elegant top in marble or wood, warmer and more natural.







Nella pagina introduttiva: tavolo Howard in rovere spessart con piano in marmo noir saint laurent lucido. Nelle pagine precedenti: tavolo Howard in rovere spessart con piano in marmo calacatta oro levigato. Sedie Ventura con e senza braccioli, rivestimento non sfoderabile in tessuto Merida 02 tortora, struttura in rovere spessart. Pouf Onda in velluto sfoderabile Persia 1403 ocra. Tappeto Soft. Qui e nella pagina successiva: tavolo Howard in olmo nero. Nella pagina in chiusura: tavolo Howard in rovere spessart. Sedie Ventura con e senza braccioli, rivestimento non sfoderabile in tessuto Naxos 16 sabbia, struttura in rovere spessart.

Introduction page: Howard table in spessart oak with top in glossy marble noir saint Laurent. Previous pages: Howard table in spessart oak with top in mat marble calacatta oro. Ventura chairs with or without armrests, cover in removable fabric Merida 02 tortora, structure in spessart oak. Onda pouf in removable velvet Persia 1403 ocra. Carpet Soft. This and next page: Howard table in black elm. Closing page: Howard table in spessart oak. Ventura chairs with and without armrests, cover in non-removable fabric Naxos 16 sabbia, structure in spessart oak.







HOWARD

Design Jean-Marie Massaud, 2011

Struttura in massello, finitura in rovere spessart o olmo nero. Telaio in metallo tagliato a laser e piegato, verniciato brown nickel opaco.
Piano in rovere spessart, cinque marmi levigati e sei lucidi.

Structure in solid wood, finishes spessart oak or black elm. Frame in laser cut and folded metal painted mat brown nickel.
Top in spessart oak, five mat and six glossy marble finishes.

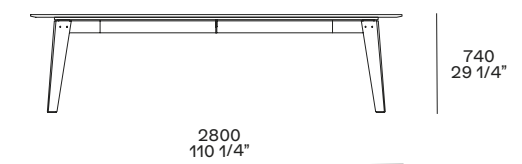
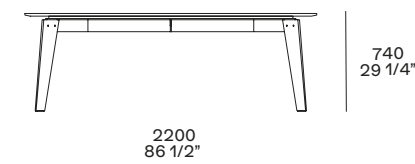



MAD DINING TABLE

Mad Dining Table è un tavolo ampio dalle delicate linee arrotondate. Il piano, in essenza o marmo, è visivamente leggero, quasi sospeso, mentre la struttura, solida e robusta, ricorda nel disegno l'omonima sedia cui si accompagna.

Mad Dining Table is a large table with delicate rounded lines. The top, in wood or marble, is visually light, almost suspended, while the structure, solid and robust, is reminiscent in its design of the homonymous chair it accompanies.





Nella pagina introduttiva: dettaglio del piano in marmo grigio stardust levigato. Nelle pagine precedenti: tavolo Mad Dining Table in rovere spessart con piano in marmo calacatta oro lucido. Sedie Mad Dining Chair senza braccioli, rivestimento non sfoderabile, esterno in pelle Nabuk 05 grafite e interno in tessuto Argo 1008 ardesia, gambe in rovere spessart. Qui e nella pagina successiva: tavolo Mad Dining Table con struttura e piano in olmo nero.

Introduction page: close up of the tabletop in mat marble grigio stardust. Previous pages: Mad Dining Table in spessart oak with top in glossy marble calacatta oro. Chairs Mad Dining Chair without armrests with non-removable cover, outside in leather Nabuk 05 grafite and inside in fabric Argo 1008 ardesia, legs in spessart oak. This and following page: table Mad Dining Table with structure and top in black elm.







MAD DINING TABLE
Design Marcel Wanders, 2015

Struttura in massello, finitura in rovere spessart o olmo nero.
Piano in rovere spessart, olmo nero, cinque marmi levigati e sei lucidi.

Structure in solid wood, spessart oak or black elm finish.
Top in spessart oak, black elm, five mat and six glossy marble finishes.

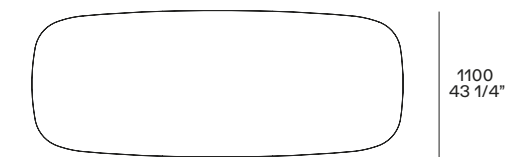
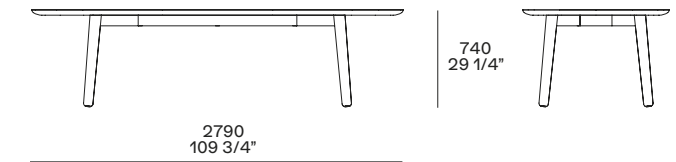
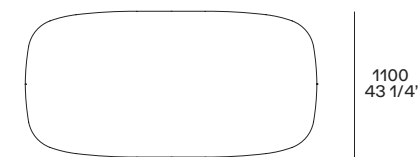
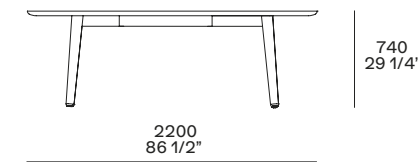

OPÉRA



Artigianalità e tecnologia, semplicità e funzionalità evolute, materiali nobili: in Opéra è riassunto il mondo di Poliform. Un tavolo fisso o allungabile dove la funzione di estensibilità è efficace e discreta. Merito di una lavorazione artigianale meticolosa, combinata con le più avanzate tecnologie di produzione.

Craftsmanship and technology, simplicity and advanced functionality, noble materials: the world of Poliform is summarized in Opéra. A fixed or extendable table where the extensibility function is effective and discreet, thanks to a meticulous craftsmanship, combined with the most advanced production technologies.





Nella pagina introduttiva: tavolo Opéra in rovere spessart con piano in marmo noir saint laurent lucido. Nelle pagine precedenti: tavolo Opéra, versione fissa, in rovere spessart con piano in marmo calacatta oro levigato. Sedie Guest con rivestimento non sfoderabile in tessuto Norway 08 avorio, cuscino seduta sfoderabile nella stessa finitura. Pouf Onda in velluto sfoderabile Persia 2006 prugna. Qui e nella pagina successiva: tavolo Opéra allungabile con struttura e piano in rovere spessart.

Introduction page: Opéra table in spessart oak with top in glossy marble noir saint laurent. Previous pages: Opéra table, fixed version, in spessart oak with top in mat marble calacatta oro. Guest chairs with non-removable cover in fabric Norway 08 avorio, seat cushion in the same removable fabric. Onda pouf in removable velvet Persia 2006 prugna. This and next page: Opéra extendable table with structure and top in spessart oak.

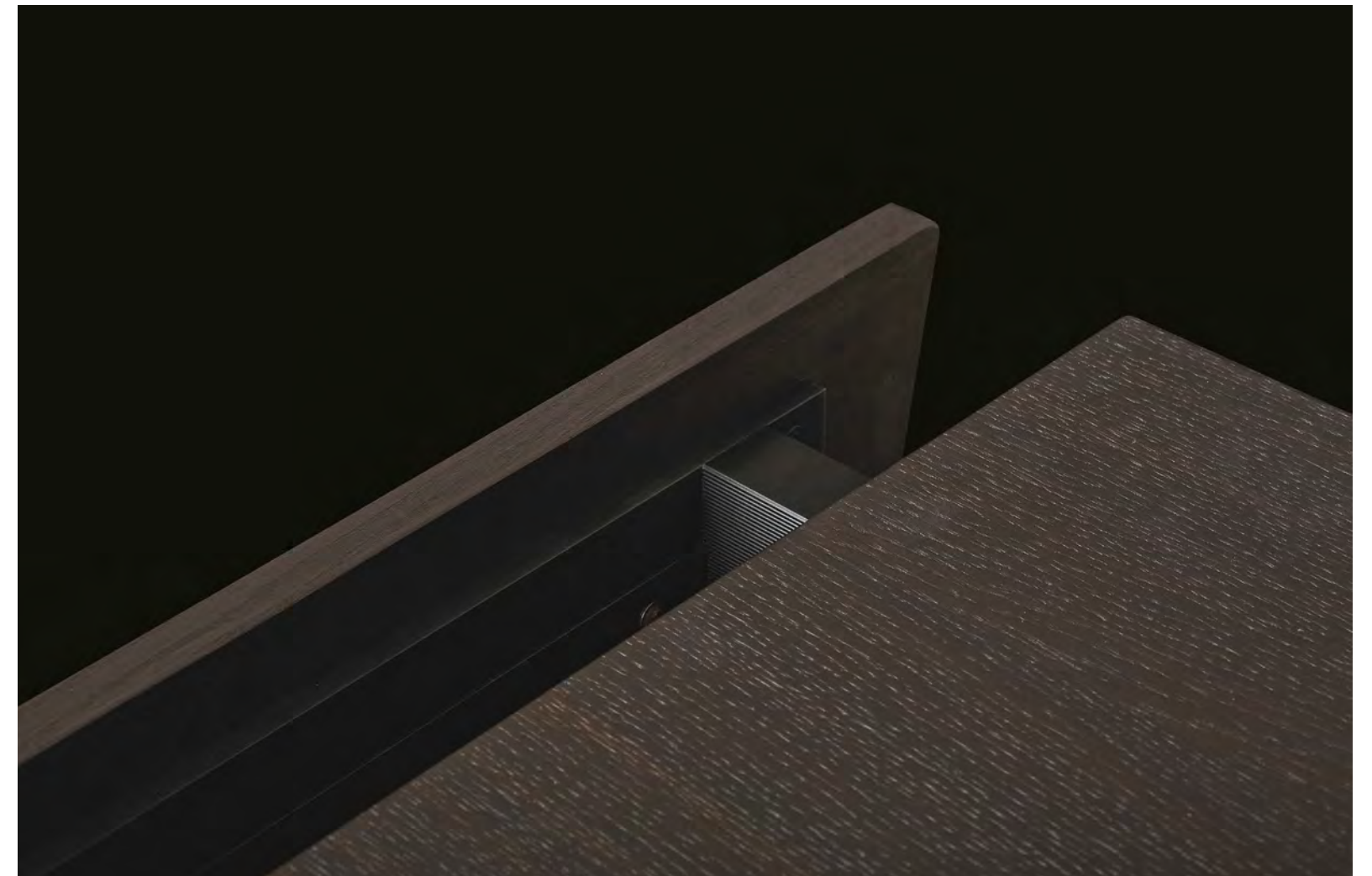





OPÉRA

Design Emmanuel Gallina, 2014

Tavolo fisso o allungabile. Struttura in massello, finitura in noce c.o rovere spessart. Piano in noce c., rovere spessart, cinque marmi levigati e sei lucidi. Le prolunghe del tavolo allungabile con piano in marmo seguono la finitura della struttura.

Fixed or extendable table. Structure in solid wood, finishes walnut c.or spessart oak. Top in walnut c., spessart oak, five mat and six glossy marble finishes. The extensions of the extendable table with marble top are in the same finish of the structure.

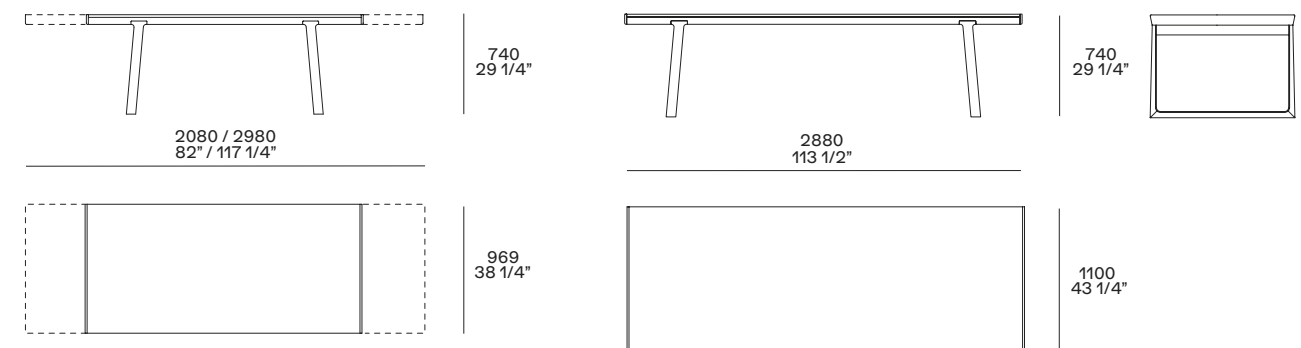



GILL

Rigore geometrico e dettagli elaborati contraddistinguono Gill, tavolo allungabile in tre misure, interamente realizzato in rovere spessart. Semplice ma per nulla banale, Gill è pensato per gli spazi più importanti perché può accogliere molti ospiti.

Geometric rigour and elaborate details distinguish Gill, an extendable table in three sizes, entirely made of spessart oak. Simple yet not at all banal, Gill is designed for the most important spaces because it can accommodate many guests.





Qui e nella pagina precedente: tavolo allungabile Gill in rovere spessart.
Nella pagina successiva: tavolo allungabile Gill in rovere spessart. Sedie
Harmony con seduta in rovere spessart e struttura in cromo nero. Madie
Pandora in rovere spessart con piedini in brown nickel opaco. Pouf Onda
in pelle non sfoderabile Special 40 ardesia.

This and next page: extendable table Gill in spessart oak. Next page:
extendable table Gill in spessart oak. Harmony chairs with seat in spes-
sart oak and structure in black chrome. Pandora sideboards in spessart
oak with feet in mat brown nickel. Onda pouf in non-removable leather
Special 40 ardesia.





GILL

Design Roberto Barbieri, 2010

Tavolo allungabile. Struttura in massello, finitura in rovere spessart. Piano in rovere spessart.

Extendable table. Structure in solid wood spessart oak finish. Top in spessart oak.

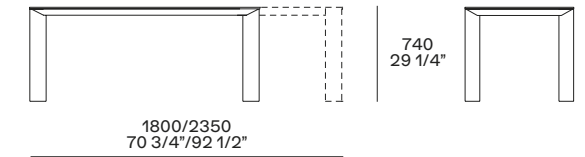
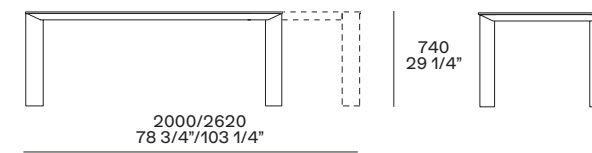
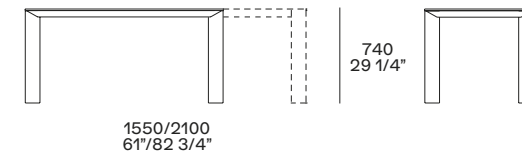



BLADE

La semplicità della forma incontra il calore del legno nel tavolo da soggiorno per eccellenza, caratterizzato da linee essenziali e geometrie elementari. Quadrato o rettangolare, in quest'ultima versione Blade è personalizzabile al centimetro.

The simplicity of the shape meets the warmth of wood in the living room table par excellence, characterized by minimalistic lines and elementary geometry. Square or rectangular, in this latest version Blade is customizable down to the centimetre.





Nelle pagine precedenti e in chiusura: tavolo Blade con struttura e piano in massello noce canaletto. Sedie Seattle con e senza braccioli, seduta rivestita in cuoio non sfoderabile 26 invecchiato, gambe in rovere naturale. Cucina Phoenix, design R&D Poliform. Basi in massello noce canaletto. Pensili con ante in vetro riflettente fumé, schienali noce c. e mensole laccato goffrato carbone. Colonne in laccato goffrato glacier white. Qui e nella pagina successiva: tavolo Blade con struttura e piano in massello tinto olmo nero.

Previous pages and closing page: Blade table with structure and top in solid walnut canaletto. Seattle chairs with and without armrests, seat covered in non-removable hide 26 invecchiato, legs in natural oak. Phoenix kitchen, design R&D Poliform. Base units in solid walnut canaletto. Wall units with doors in fumé reflecting glass, backs in walnut c. and carbone embossed lacquered shelves. Glacier white embossed lacquered tall units. This and next page: Blade table with structure and top in solid wood stained black elm.

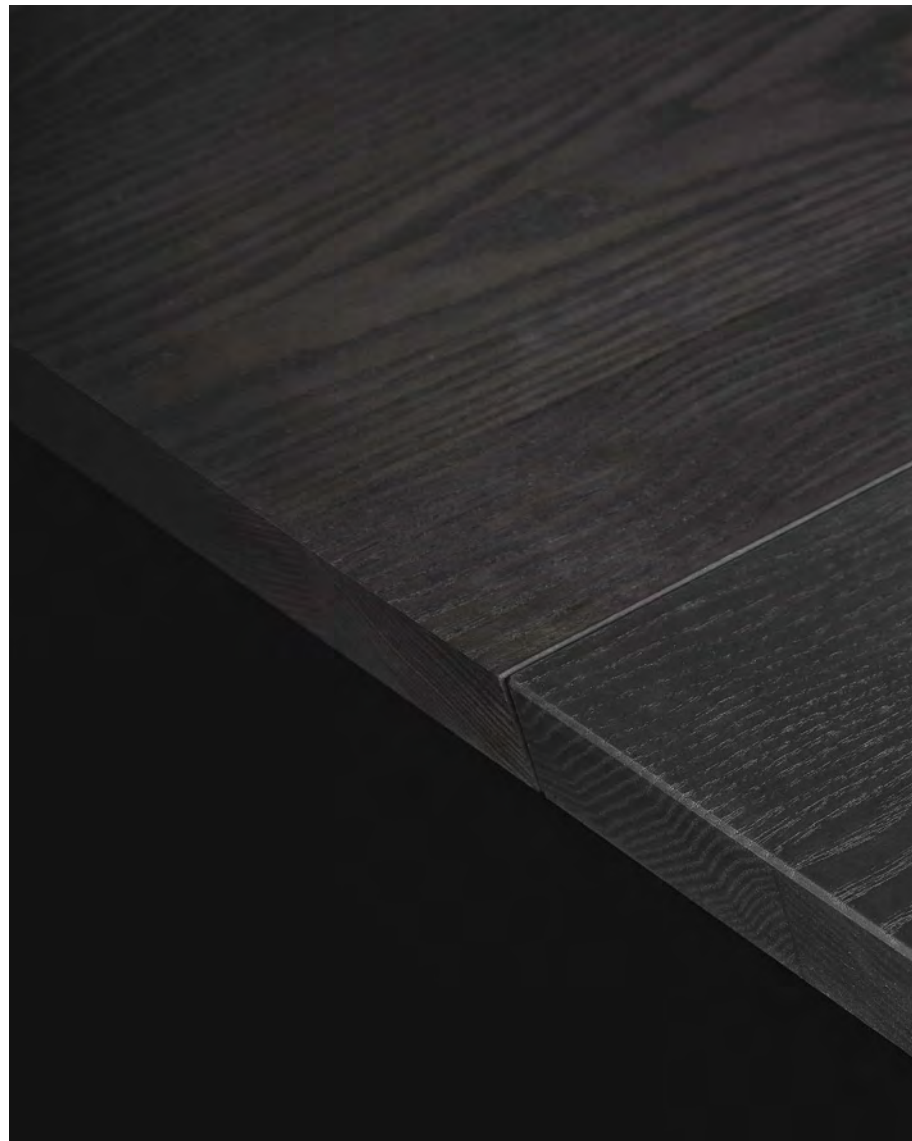





BLADE

Design R&D Poliform, 2014

Struttura e piano in massello di noce canaletto o massello tinto olmo nero.
Nella versione rettangolare la lunghezza del tavolo si può personalizzare al centimetro.

Structure and top in solid wood walnut Canaletto or in solid wood stained black elm.
In the rectangular version, the table length is customizable to the centimeter.

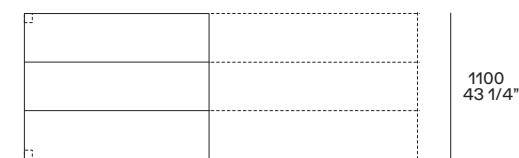
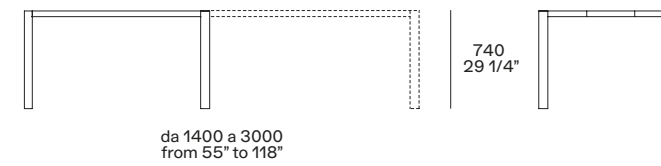
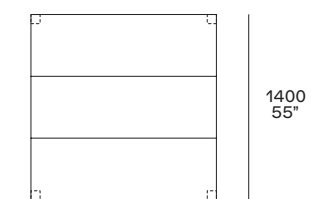
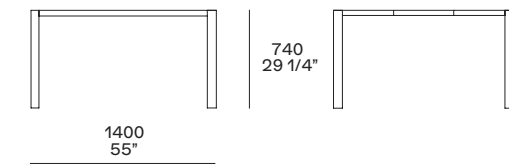
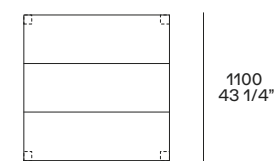
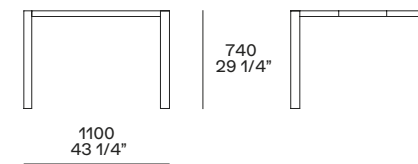

TREVI

Per il suo design essenziale fatto di geometrie e di spessori effimeri, Trevi è un tavolo che si può adattare a diversi ambienti della casa. Disponibile in versione quadrata o rettangolare, ha il piano e le gambe in finitura laccata opaca, anche in versione antigraffio.

Because of its minimalistic design made of ephemeral geometry and thicknesses, Trevi is a table that can adapt to several environments of the house. Available in square or rectangular version, it has the top and legs in mat lacquered finish, also in an anti-scratch version.







TREVI

Design Roberto Barbieri, 2005

Struttura in trafilato alluminio laccato opaco colori, laccato antigraffio nei colori bianco 01, carbone 91, grafite 04, canapa 35 o verniciato brown nickel opaco e lucido. Piano in laccato opaco colori o laccato antigraffio nei colori bianco 01, carbone 91, grafite 04 e canapa 35.

Structure in extruded aluminium in the finishes mat lacquered colours, glossy lacquered colours, anti-scratch lacquer in the colours bianco 01, carbone 91, grafite 04, canapa 35 or brown nickel mat and glossy. Top in the finishes mat lacquered colours, glossy lacquered colours, anti-scratch lacquer in the colours bianco 01, carbone 91, grafite 04, canapa 35.

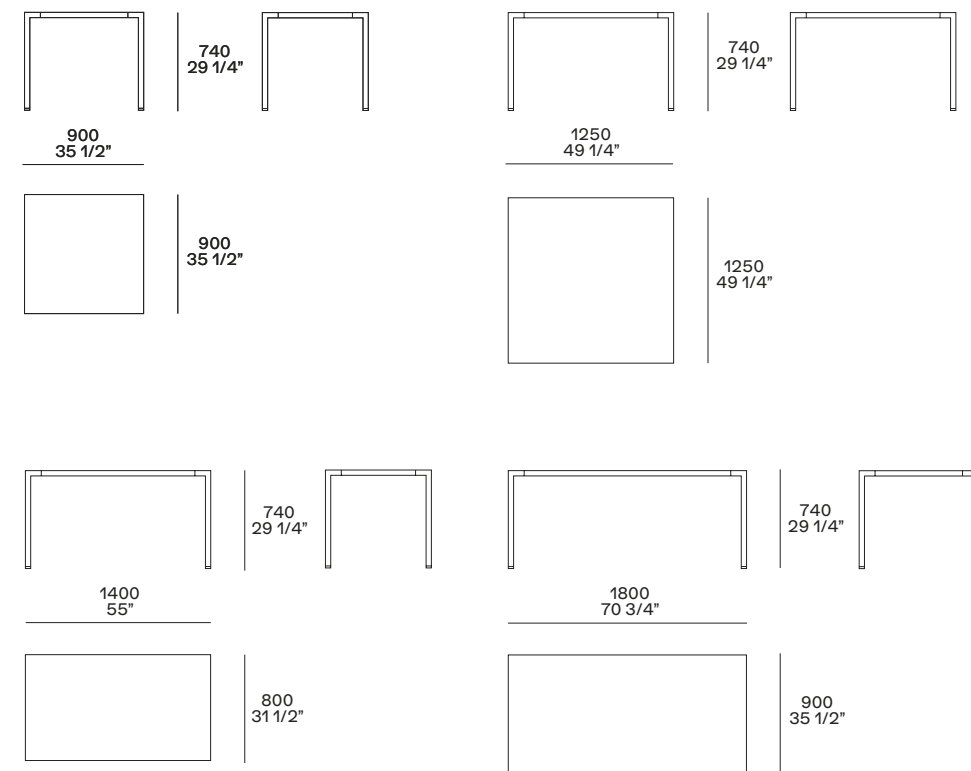

Nella pagina precedente: tavolo Trevi in brown nickel opaco con piano in laccato opaco carbone. In questa pagina: tavolo Trevi con struttura e piano in laccato opaco bianco.

Previous page: Trevi table in mat brown nickel with carbone mat lacquered top. This page: Trevi table with bianco mat lacquered structure and top.

DESKS

Classico protagonista di ambienti dedicati allo studio e al lavoro, complemento indispensabile di librerie e biblioteche, lo scrittoio è oggi un elemento colto e attuale nella zona giorno, discreto e intimo nella zona notte. Emmanuel Gallina e Jean-Marie Massaud lo reinterpretano con la consueta raffinatezza, tra estetica e funzionalità, con materiali di pregio e dettagli esclusivi come i piani sottomano opzionali in cuoio e i piccoli cassetti. Perfeziona la collezione Mathieu, scrittoio-toeletta che per le sue linee delicate è l'ideale completamento delle zone notte più contemporanee.

Classic protagonist of environments dedicated to study and work, an indispensable complement of bookstores and libraries, the writing desk is now a cultured and current element in the day area, discreet and intimate in the night area. Emmanuel Gallina and Jean-Marie Massaud reinterpret it with the usual refinement, between look and functionality, with prestigious materials and exclusive details such as the optional leather pads and small drawers. To perfect the collection there is Mathieu, writing desk that with its delicate lines is the ideal closing touch to the most contemporary night areas.

DESKS

MATHIEU	337
HOME HOTEL	345
HOME HOTEL CONSOLE	350
CONCORDE	357

MATHIEU

Mathieu è uno scrittoio dalla silhouette slanciata e dai profili delicati. Il piano, con cornice in essenza e inserto in cuoio, disegna curve delicate che addolciscono le linee decise della struttura, in metallo verniciato. Eleganti e discreti gli accessori opzionali: il piccolo cassetto sottopiano e lo specchio.

Mathieu is a writing desk with a slender and delicate profile. The top, with wooden frame and leather insert, draws delicate curves that soften the precise lines of the structure, in painted metal. Elegant and discreet are the optional accessories: the small under mount drawer and the mirror.



Nella pagina precedente e nella successiva: scrittoio Mathieu con struttura brown nickel lucido, piano con cornice rovere spessart e inserto in cuoio 29 tortora. Cassetto sottopiano in laccato carbone e specchio con struttura brown nickel lucido. Sedia Guest con rivestimento non sfoderabile in pelle Soft 10 prugna, cuscino seduta sfoderabile nella stessa finitura. In questa pagina: scrittoio Mathieu con struttura brown nickel lucido, piano con cornice olmo nero e inserto in cuoio 02 nero. Cassetto sottopiano in laccato carbone.

Previous and next page: Mathieu writing desk with glossy brown nickel structure, top with frame in spessart oak and inlay in hide 29 tortora. Carbone lacquered undermount drawer and mirror with glossy brown nickel support. Guest chair with non-removable cover in leather Soft 10 prugna, seat cushion with removable cover in the same material. This page: Mathieu writing desk with glossy brown nickel structure, top with black elm frame and inlay in hide 02 nero. Carbone mat lacquered undermount drawer.





MATHIEU

Design Emmanuel Gallina, 2017

Struttura in metallo verniciato brown nickel opaco o lucido. Piano con cornice in rovere spessart o olmo nero con inserto in cuoio nei colori 19 caffè, 02 nero, 03 grigio scuro e 29 tortora. Il piano è disponibile anche con specchio in metallo verniciato brown nickel opaco o lucido. È previsto un cassetto sottopiano opzionale in laccato carbone.

Structure in painted metal mat or glossy brown nickel. Top with frame in spessart oak or black elm with inlay in hide in the colours 19 caffè, 02 nero, 03 grigio and 29 tortora. The top is available also with mirror in mat or glossy brown nickel painted metal. An optional undermount drawer in mat lacquer carbone is available.

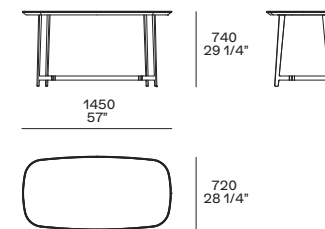



HOME HOTEL

Eleganza e versatilità sono il fil rouge della collezione con cui Jean-Marie Massaud reinterpreta gli spazi dell'abitare contemporaneo. Nelle sue due declinazioni, Home Hotel è uno scrittoio solido e leggero oppure una consolle. Lo scrittoio, in olmo nero, è disponibile con o senza cassetto e piano sotto-mano in cuoio.

Elegance and versatility are the common thread of the collection with which Jean-Marie Massaud reinterprets the space of contemporary living. In its two versions, Home Hotel is a solid and light writing desk or a console table. The desk, in black elm, is available with or without drawer and leather pad.



Qui e nella pagina precedente: scrittoio Home Hotel con struttura, piano e cassetto sottopiano in olmo nero, sottomano in cuoio 02 nero. Sedia Sophie con braccioli, rivestimento non sfoderabile in pelle Soft 02 mastice, struttura in olmo nero.

This and previous page: Home Hotel writing desk with structure, top and undermount drawer in black elm, desk pad in hide 02 nero. Sophie chair with armrests, cover in non-removable leather Soft 02 mastice, structure in black elm.





In questa pagina: consolle Home Hotel con struttura e piano in olmo nero, in appoggio sul piano contenitore Vanity in laccato opaco vischio.

This page: Home Hotel console with structure and top in black elm, vischio mat lacquered Vanity storage unit leant on the top.



In questa pagina: contenitore Vanity in laccato opaco vischio, griglia interna in olmo nero, fondo in tecnopelle 05 latte e specchio interno. Nella pagina successiva: consolle Home Hotel con struttura e piano in olmo nero. Divano Bristol rivestimento sfoderabile in tessuto Kitami 02 cenere.

This page: vischio mat lacquered Vanity storage unit, inner partition in black elm, bottom in techno leather 05 latte and inner mirror. Next page: Home Hotel with structure and top in black elm. Bristol sofa with removable cover in fabric Kitami 02 cenere.

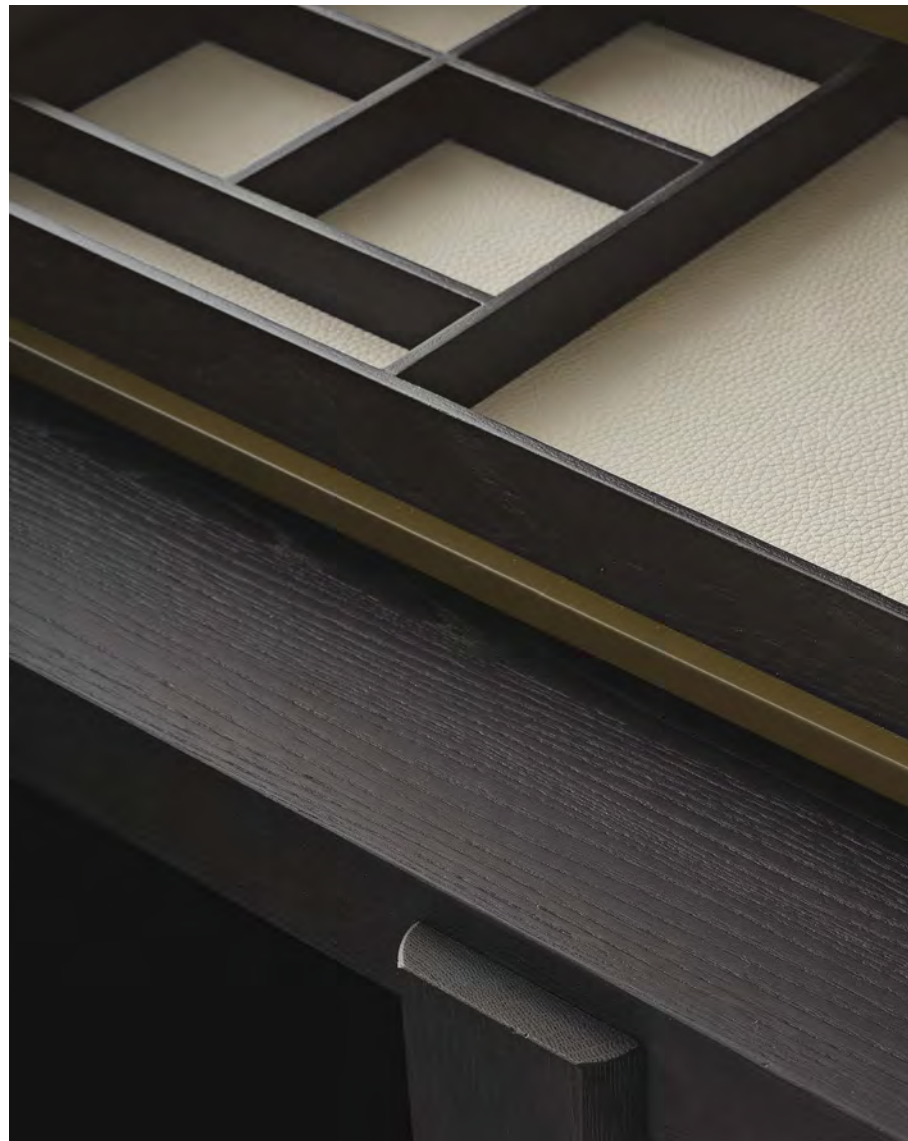



HOME HOTEL

Design Jean-Marie Massaud, 2016

Scrivania con struttura in massello finitura olmo nero. Piano in olmo nero. Il piano è disponibile anche con sottomano in cuoio. È previsto un cassetto sottopiano opzionale in laccato carbone.

Consolle con struttura in massello finitura olmo nero. Piano in olmo nero.

Contenitore Vanity, opzionale in appoggio al piano, in laccato opaco colori con griglia interna in olmo nero, fondo in tecnopelle e specchio interno.

Writing desk with structure in solid wood in black elm finish. Top in black elm. The top is available also with desk pad in hide.

An optional undermount drawer in lacquer carbone is available.

Console with structure in solid wood with black elm finish. Top in black elm.

Optional Vanity storage unit leant on top in mat lacquered colours with inner partition in black elm, bottom in techno leather and inner mirror.

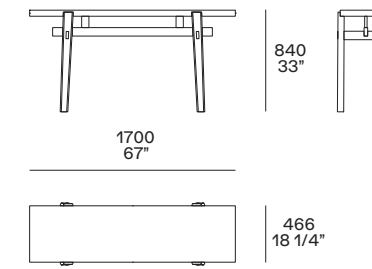
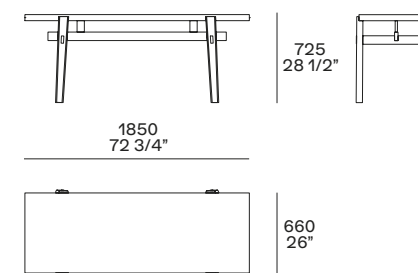

Vanity

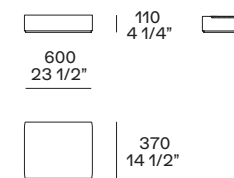

CONCORDE

Emmanuel Gallina ridisegna le forme leggere ed essenziali del tavolo Concorde realizzando lo scrittoio ideale per lo studio di casa con un'accurata scelta dei materiali. Concorde è disponibile con o senza cassetto e piano sottomano in cuoio.

Emmanuel Gallina redesigns the light and minimalistic shapes of the Concorde table, creating the ideal writing desk for the house study with an accurate choice of materials. Concorde is available with or without drawer and leather pad.



Nella pagina precedente e nella successiva: scrittoio Concorde in rovere spessart con sottomano in cuoio 02 nero. Sedia Manta con braccioli, rivestimento non sfoderabile in pelle Vintage 96 nero. Pouf Onda in velluto sfoderabile Persia 1401 oliva. Boiserie Dream velluto Persia 1404 carbone con mensole laccato lucido visone. In questa pagina: scrittoio Concorde in olmo nero con sottomano in cuoio 38 oliva e cassetto sottopiano in laccato carbone.

Previous and next page: Concorde in spessart oak with desk pad in hide 02 nero. Manta chair with armrests, cover in non-removable leather Vintage 96 nero. Onda pouf in removable velvet Persia 1401 oliva. Dream wall panelling in velvet Persia 1404 carbone with visone glossy lacquered shelves. This page: Concorde writing desk in black elm with desk pad in hide 38 oliva and undermount drawer glossy lacquered carbone.

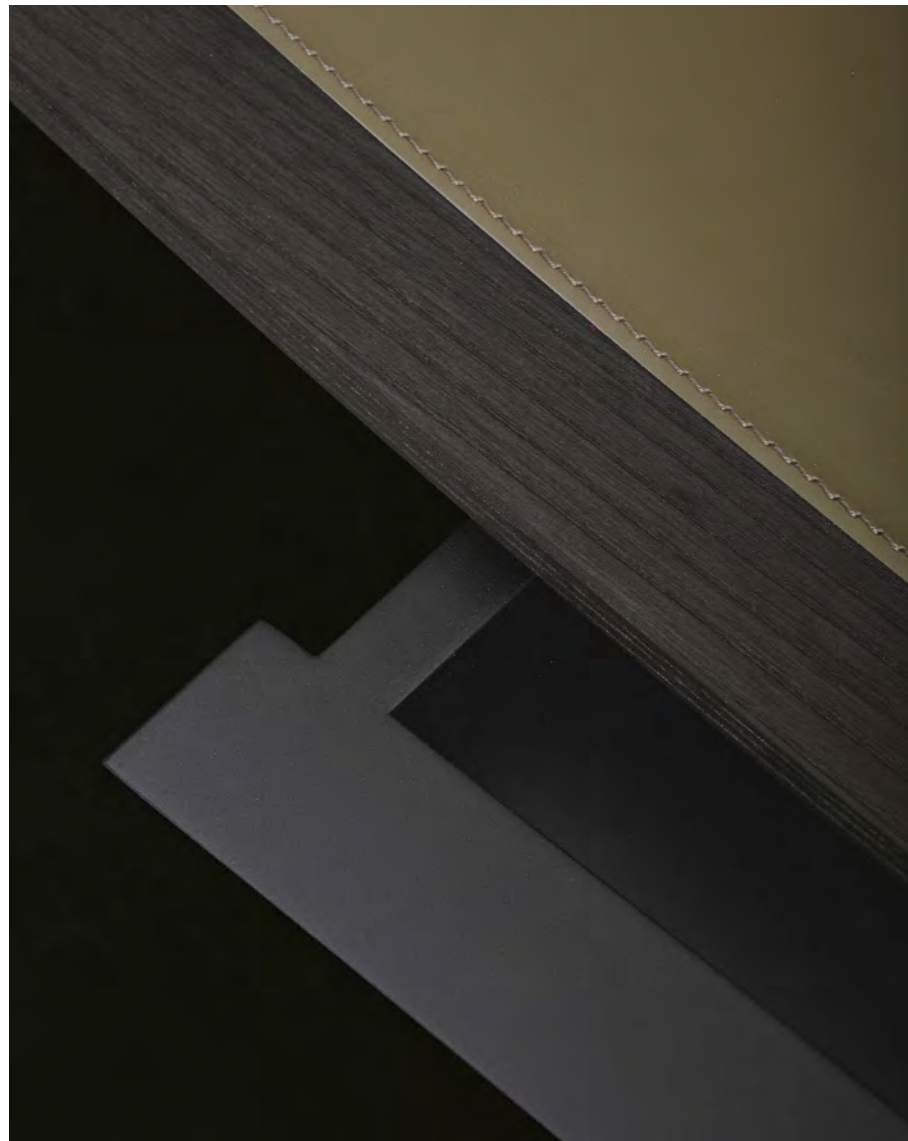

CONCORDE

Design Emmanuel Gallina, 2009

Struttura in massello finitura noce c., rovere spessart, rovere cenere o olmo nero.

Piano in noce c., rovere cenere, rovere spessart o olmo nero. Il piano è disponibile anche con sottomano in cuoio. È previsto un cassetto sottopiano opzionale in laccato carbone.

Structure in solid wood in the finishes walnut c., spessart oak, cenere oak or black elm. Top in walnut c., cenere oak, spessart oak or black elm. The top is available also with desk pad in hide. An optional undermount drawer in lacquer carbone is available.

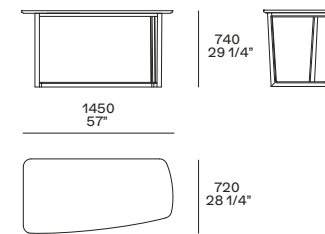

SIDEBOARDS

Espositori e contenitori allo stesso tempo, le madie sono complementi immancabili nella zona giorno. Dall'elemento più semplice al sistema complesso, dallo stile classico a quello contemporaneo, sempre con un occhio di riguardo ai materiali, la collezione di madie di Poliform è molto variegata, grazie alle proposte dei designer Jean-Marie Massaud, Carlo Colombo, Rodolfo Dordoni, Marcel Wanders e Studio Kairos.

Display and storage units at the same time, sideboards are essential additions to the day area. From the simplest element to the complex system, from the classic style to the contemporary one, always with a special attention to materials, Poliform's collection of sideboards is very varied, thanks to the offers by the designers Jean-Marie Massaud, Carlo Colombo, Rodolfo Dordoni, Marcel Wanders and Studio Kairos.

SIDEBOARDS

HOME HOTEL	369
FREE	383
FEBE	397
PANDORA	411
BRISTOL	425
BRISTOL BOOKCASE	438
GIÒ	447
THECA	461



HOME HOTEL

La madia Home Hotel richiama gli altri arredi dell'omonima serie, tavoli e panche cui si abbina con naturalezza. Caratterizzata dai frontali sagomati con bordo in essenza e dalla particolare base con piedini, Home Hotel è disponibile in versione alta o bassa.

The Home Hotel sideboard is reminiscent of the other furnishings of the homonymous series; tables and benches it naturally matches. Characterized by the shaped fronts with wooden edge and the particular base with feet, Home Hotel is available in high or low version.



Nella pagina precedente e nella successiva: madia Home Hotel in rovere spessart, ante e cassetti con frontali sagomati laccato metallico ottone e bordo in olmo nero. Interno struttura laccato opaco ottone. In questa pagina: madia Home Hotel in olmo nero, ante e cassetti con frontali sagomati laccato opaco granata e bordo in olmo nero. Interno struttura laccato opaco granata.

Previous and next page: Home Hotel sideboard in spessart oak, doors and drawers with shaped fronts in ottone metal lacquer and black elm edge. Ottone mat lacquered inner structure. This page: Home Hotel sideboard in black elm, doors and drawers with granata mat lacquered shaped fronts and black elm edge. Granata mat lacquered inner structure.







In questa pagina: madia Home Hotel in olmo nero, ante e cassetti con frontali sagomati laccato opaco carbone e bordo in olmo nero. Interno struttura laccato opaco carbone.

This page: Home Hotel sideboard in black elm, doors and drawers with carbone mat lacquered shaped fronts and black elm edge. Carbone mat lacquered inner structure.



In questa pagina: madia Home Hotel in olmo nero, ante e cassetti con frontali sagomati laccato opaco caramello e bordo in olmo nero. Interno struttura laccato opaco caramello e bordo in olmo nero. Sedia Stanford Bridge rivestimento non sfoderabile in tessuto Kitami 04 sabbia, basamento girevole in brown nickel lucido. Tavolo Kensington struttura in spatolato bronzo e piano in olmo nero. Nella pagina successiva: dettaglio dei frontali sagomati laccato metallico ottone con bordo frontali, basamento e piedino in rovere spessart.

This page: Home Hotel sideboard in black elm, doors and drawers with caramello mat lacquered shaped fronts and edge in black elm. Caramello mat lacquered inner structure. Stanford Bridge chair with non-removable cover in fabric Kitami 04 sabbia, swivel base in glossy brown nickel. Kensington table with structure in bronzo with spatula effect and top in black elm. Next page: close up of the shaped fronts in ottone metal lacquer with edge, base and feet in spessart oak.





HOME HOTEL

Design Jean-Marie Massaud, 2018

Struttura esterna in rovere spessart o olmo nero. Frontali sagomati in laccato opaco colori, laccato metallico ottone o bronzo con bordo in rovere spessart o olmo nero. Basamento e piedini in massello, finitura in rovere spessart o olmo nero. Interno struttura in laccato opaco nello stesso colore dei frontali. Attrezzature: ripiani nei vani con ante. Attrezzature opzionali medie Home Hotel basse: attrezzature per cassetto in rovere spessart con fondo cassetto in tecnopelle colori.

External structure in spessart oak or black elm. Shaped fronts in mat lacquered colours, metal lacquered ottone or bronzo with edge in spessart oak or black elm. Base and feet in solid wood, spessart oak or black elm finish. Inner structure mat lacquered in the same colour of the fronts. Equipment: inner shelves behind the doors. Optional accessories for low Home Hotel sideboards: equipment for drawer in spessart oak, drawer bottom in techno leather in the available colours.

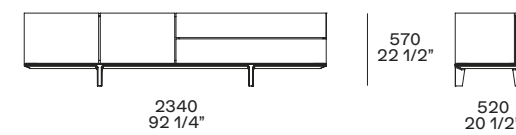

Due ante battenti e due cassetti.
Two leaf doors and two drawers.

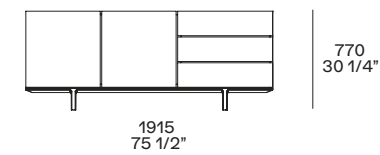

Due ante battenti e tre cassetti.
Two leaf doors and three drawers.

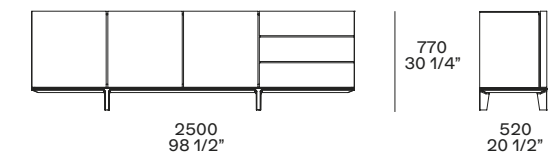

Tre ante battenti e tre cassetti.
Three leaf doors and three drawers.

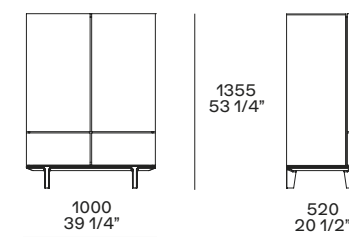

Due ante battenti e due cassetti.
Two leaf doors and two drawers.

FREE

Un monolite dalle forme stilizzate e geometriche alla Piet Mondrian da interpretare in libertà, scegliendo tra tutte le possibilità offerte dai colori laccati opachi e lucidi. In versione alta o bassa, la madia Free può essere attrezzata con accessori opzionali come il porta posate e il porta bottiglie.

A monolith with stylized and geometric shapes in Piet Mondrian style to be freely interpreted, choosing from all the options offered by the mat and glossy lacquered colours. In high or low version, the sideboard Free can be equipped with optional accessories such as the cutlery holder and the bottle holder.



Nella pagina precedente: madia Free laccato opaco muschio. In questa pagina: madia Free laccato lucido visone. Sotto: dettaglio del portaposate estraibile in rovere spessart con piano e frontale rivestiti in cuoio 19 caffè.

Previous page: muschio mat lacquered Free sideboard. This page: visone glossy lacquered Free sideboard. Below: close up of the extractable cutlery tray in spessart oak with shelf and front covered in hide 19 caffè.







Nella pagina precedente: madia Free laccato lucido canapa con profilo maniglia in rovere spessart. In questa pagina: madia Free laccato opaco arena. Sotto: dettaglio del cassetto attrezzato con porta bottiglie in rovere spessart.

Previous page: canapa glossy lacquered Free sideboard with handle profile in spessart oak. This page: arena mat lacquered Free sideboard. Below: close up of the drawer with bottle holder in spessart oak.

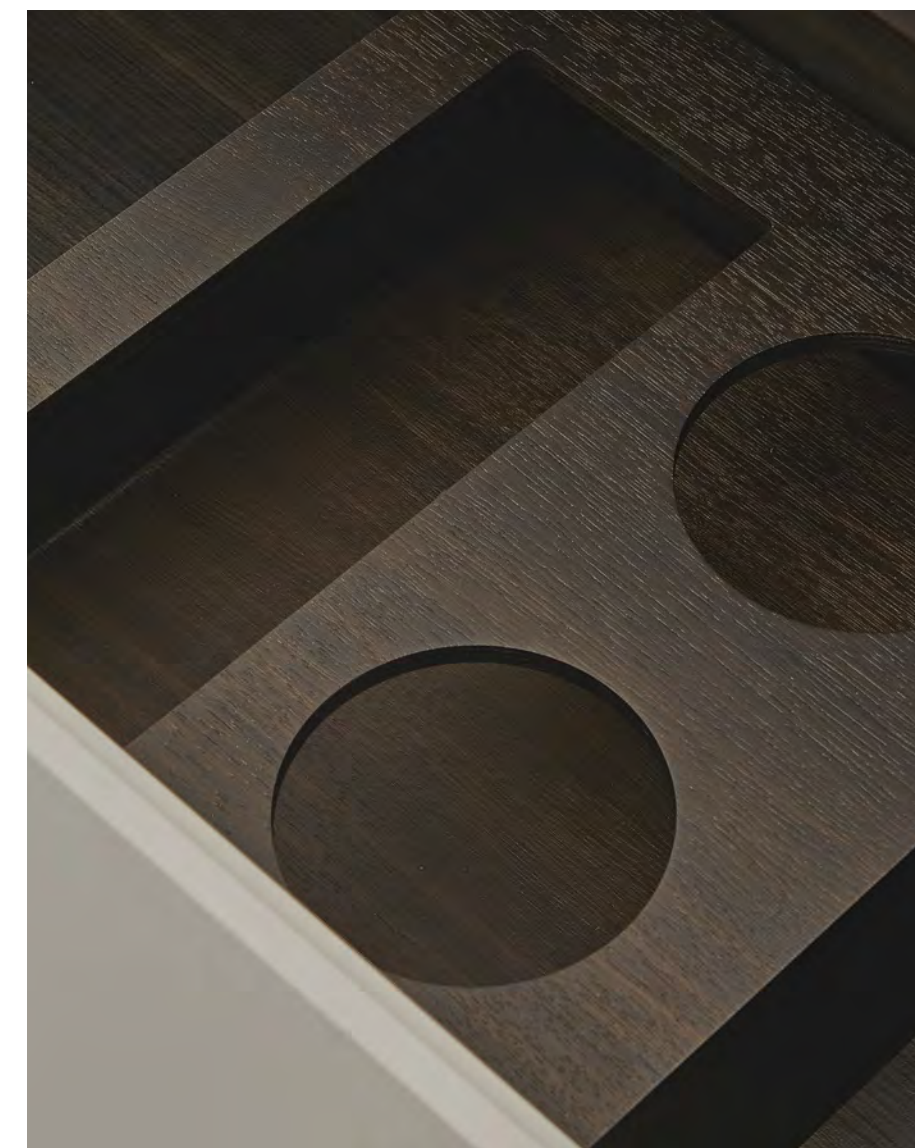

In questa pagina: madia Free laccato lucido ocra. Composizioni Wall System in rovere cenere e griglie interne laccato opaco moka. Pouf Onda in velluto sfoderabile 1404 carbone. Tappeto Stripes. Nella pagina successiva: madia Free laccato lucido ocra con dettaglio dell'interno dei cassetti in nobilitato rovere spessart.

This page: ocra glossy lacquered Free sideboard. Wall System compositions in cenere oak and moka mat lacquered partitions. Onda pouf in removable velvet 1404 carbone. Carpet Stripes. Next page: ocra glossy lacquered Free sideboard with close up of the drawer inner accessories in spessart oak.

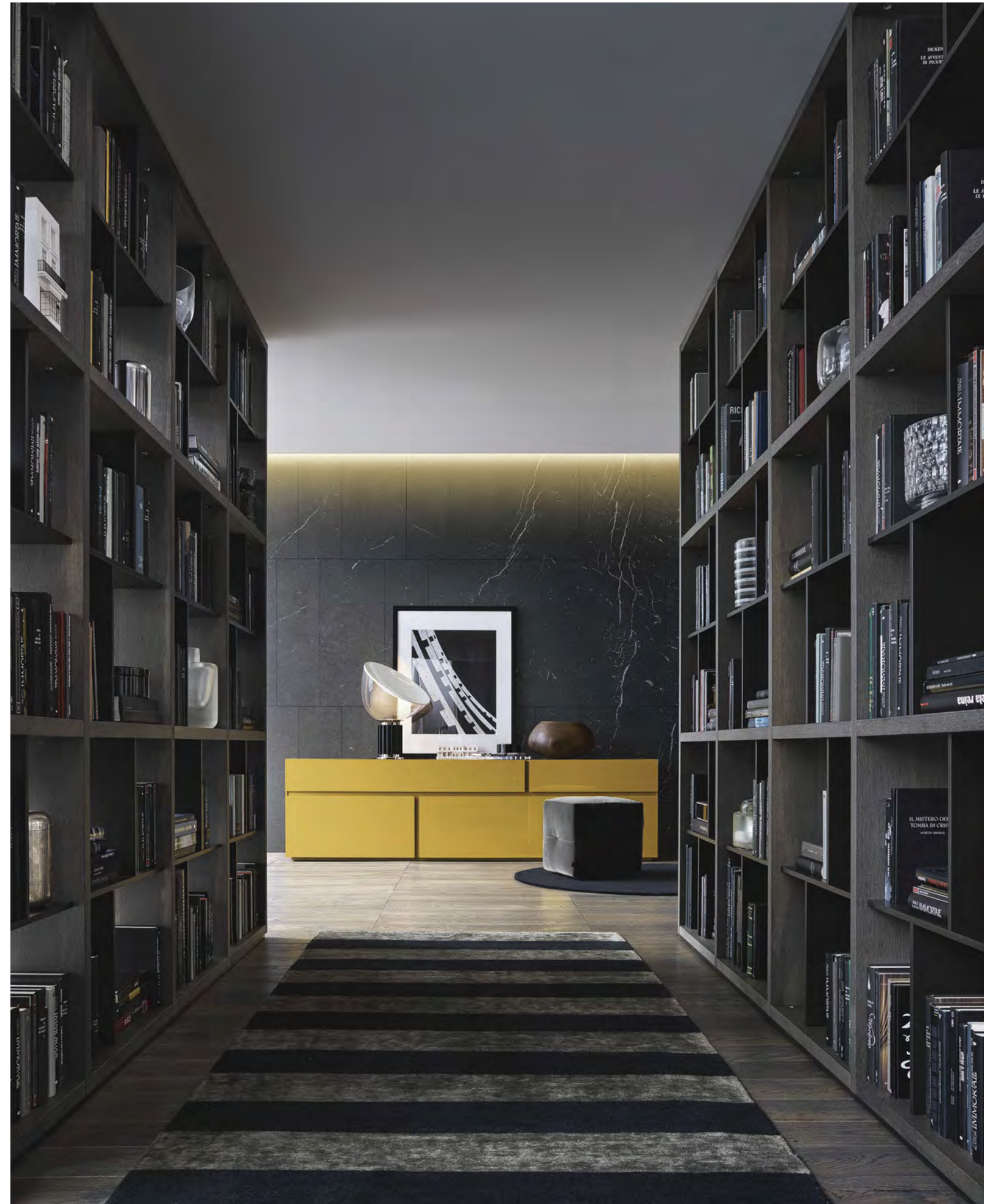



FREE

Design Carlo Colombo, 2008

Struttura e frontali in laccato opaco colori o laccato lucido colori. Interno struttura in laccato opaco colori con profilo maniglia in laccato opaco colori, noce c. o rovere spessart.

Attrezzature: ripiani nei vani con ante.
Attrezzature medie Free basse: un vassoio scorrevole asportabile in rovere spessart, in appoggio in uno dei due vani interni dell'estrattore.

Attrezzature opzionali media Free bassa: portabottiglie in rovere spessart, attrezzature per cassetto in rovere spessart con fondo cassetto in tecnopelle colori.
Attrezzature opzionali media Free alta: porta posate estraibile in rovere spessart con piano e frontale rivestiti in cuoio 19 caffè.

Structure and fronts in mat lacquered colours or glossy lacquered colours. Inner structure in mat lacquered colours with handle profile in mat lacquered colours, walnut c. or spessart oak.

Equipment: shelves behind the doors.
Accessories sideboard Free, low version: one removable extractable tray in spessart oak in one of the two inner compartments of the pullout.

Optional accessories sideboard Free, low version: bottle holder in spessart oak, equipment for drawers in spessart oak, drawer bottom in techno leather in the available colours.

Optional accessories sideboard Free, high version: cutlery tray in spessart oak with shelf and front covered in hide 19 caffè.

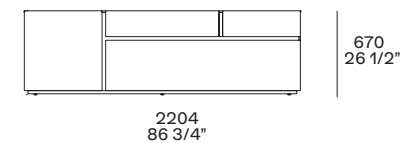

Un'anta battente, due cassetti, un estrattore con due vani interni.
One leaf door, two drawers, one pullout with two inner compartments.

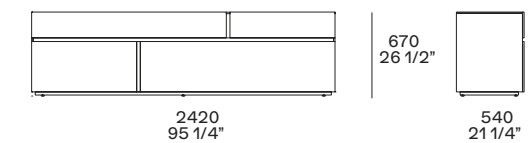

Tre cassetti, un estrattore con due vani interni.
Three drawers, one pullout with two inner compartments.

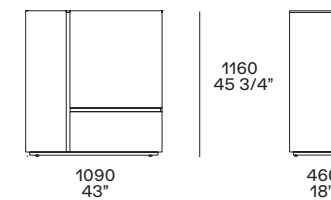

Due ante battenti e un cassetto.
Two leaf doors and one drawer.

FEBE

Disegnata da Studio Kairos, la madia Febe è caratterizzata da linee rigorose che rendono più contemporaneo il suo aspetto classico. Pensata per gli ambienti della convivialità, è allo stesso tempo contenitore ed espositore grazie ai vani aperti o chiusi dall'anta a ribalta in vetro.

Designed by Studio Kairos, the sideboard Febe is characterized by rigorous lines that make its classic look more contemporary. Designed for the convivial environments, it is at the same time a storage and a display unit thanks to the open compartments or compartments closed by the glass flap door.





Nella pagina precedente: madie Febe in rovere cenere con anta a ribalta in vetro trasparente riflettente e luce led integrata. Basamento e profili maniglia in brown nickel opaco. Sedia Grace rivestimento non sfoderabile in pelle Special 48 nocciola, struttura in rovere cenere. Tavolo Concorde in rovere cenere con piano in marmo calacatta oro levigato. Pouf Onda in tessuto sfoderabile Norway 02 ardesia. In questa pagina: madie Febe in rovere cenere. Basamento e profili maniglia in brown nickel opaco. Sotto: dettaglio del cassetto con fondo in tecnopelle 05 latte.

Previous page: Febe sideboards in cenere oak with flap door in transparent reflecting glass and integrated led light. Base and handle profiles in mat brown nickel. Grace chair with non-removable cover in leather Special 48 nocciola, structure in cenere oak. Concorde table in cenere oak with top in mat marble calacatta oro. Onda pouf in removable fabric Norway 02 ardesia. This page: Febe sideboards in cenere oak. Base and handle profiles in mat brown nickel. Below: close up of the drawer with bottom in techno leather 05 latte.



In questa pagina: madia Febe in olmo nero con anta a ribalta in vetro trasparente riflettente e luce led integrata. Basamento e profili maniglia in brown nickel opaco. Sotto: dettaglio del ripiano interno in tecnopelle 05 latte con bordo frontale in olmo nero. Nella pagina successiva: madia Febe in olmo nero con basamento e profili maniglia in brown nickel lucido.

This page: Febe sideboard in black elm with flap door in transparent reflecting glass and integrated led light. Base and handle profiles in mat brown nickel. Below: close up of the inner shelf in techno leather 05 latte with front edge in black elm. Next page: Febe sideboard in black elm with base and handle profiles in glossy brown nickel.







In questa pagina: madia Febe in rovere cenere con anta a ribalta in vetro trasparente riflettente e luce led integrata. Basamento e profili maniglia in brown nickel opaco. Sotto: dettaglio del cassetto interno con frontale in rovere cenere, fondo in tecnopelle 01 elefante e attrezzatura opzionale in rovere spessart. Nella pagina successiva: dettaglio del vano con anta a ribalta attrezzato con ripiano in vetro fumé e luce led integrata.

This page: Febe sideboard in cenere oak with flap door in transparent reflecting glass and integrated led light. Base and handle profiles in mat brown nickel. Below: close up of the inner drawer with front in cenere oak, bottom in techno leather 01 elefante and optional accessories in spessart oak. Next page: close up of the compartment with flap door accessorized with shelf in fume glass and integrated led light.

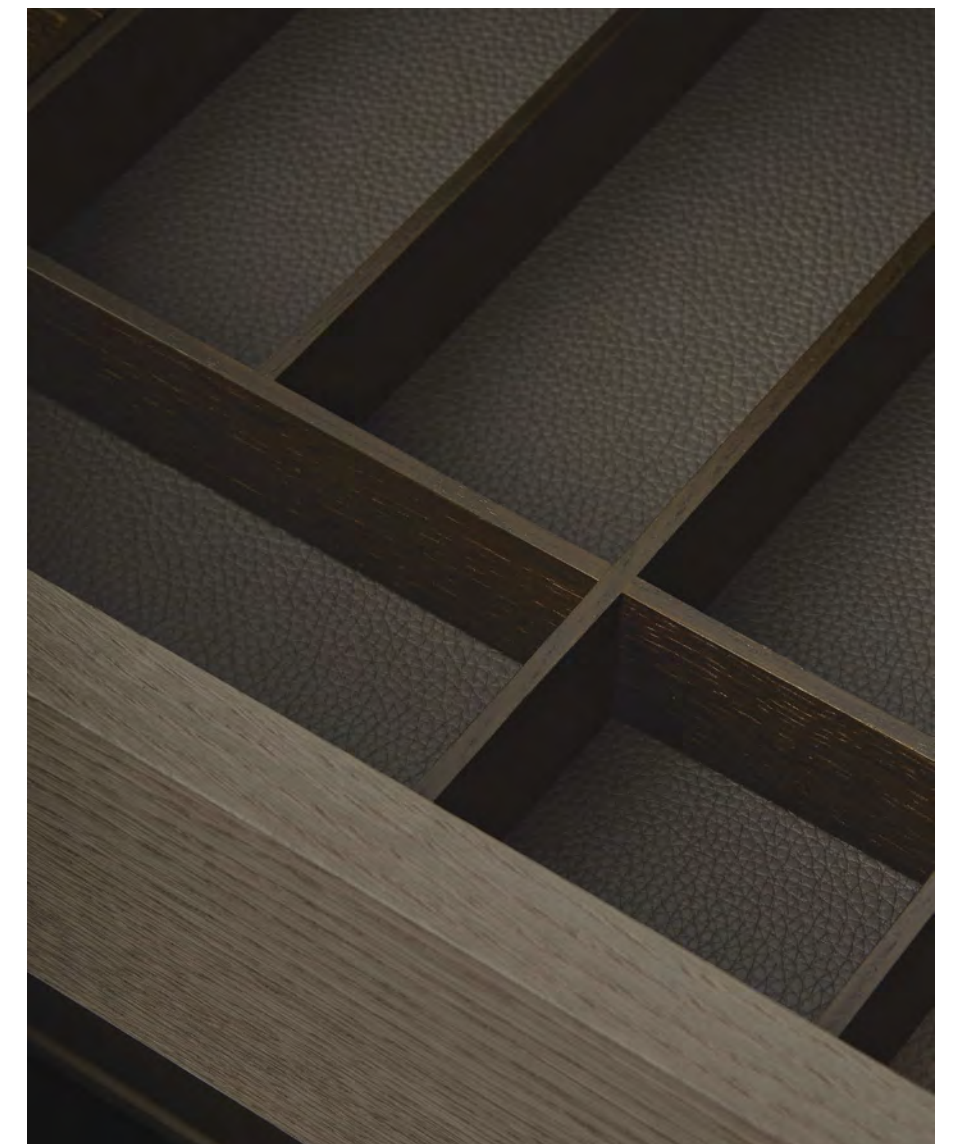



FEBE

Design Studio Kairos, 2015

Struttura e frontali in rovere spessart, rovere cenere o olmo nero. Febe alta con anta ribalta in vetro trasparente riflettente. Top in rovere spessart, rovere cenere, olmo nero, quattro marmi levigati e cinque lucidi (escluso emperador dark).

Basamento e profili maniglia in alluminio verniciato brown nickel opaco o lucido. Attrezzature media Febe bassa: ripiano nei vani con ante in tecnopelle colori con bordo frontale in rovere spessart, rovere cenere o olmo nero. Cassetto con fondo in tecnopelle colori.

Attrezzature opzionali media Febe bassa: attrezzature per cassetto in rovere spessart.

Attrezzature media Febe alta: luce led integrata e ripiano interno in vetro fumé per vano con anta a ribalta. Nei vani con ante battenti: ripiano in tecnopelle colori con bordo frontale in rovere spessart, rovere cenere o olmo nero e un cassetto con frontale in rovere spessart, rovere cenere o olmo nero e fondo in tecnopelle colori.

Attrezzature opzionali media Febe alta: attrezzature per cassetto in rovere spessart.

Structure and fronts in spessart oak, cenere oak or black elm. Febe in the high version with flap door in transparent reflecting glass. Top in spessart oak, cenere oak, black elm, four mat and five glossy marble finishes (except emperador dark).

Base and handle profiles in brown nickel mat or glossy painted aluminium.

Equipment Febe sideboard, low version: shelf behind the doors, in techno leather in the available colours with front edge in spessart oak, cenere oak or black elm.

Drawer with bottom in techno leather in the available colours. Optional accessories Febe sideboard, low version: accessories for drawer in spessart oak. Equipment Febe sideboard, high version: integrated led light and inner shelf in fume glass behind the flap door. Behind leaf doors: shelf in techno leather in the available colours with front edge in spessart oak, cenere oak or black elm; one drawer with front in spessart oak, cenere oak or black elm and techno leather bottom in the available colours. Optional accessories Febe sideboard, high version: accessories for drawer in spessart oak.

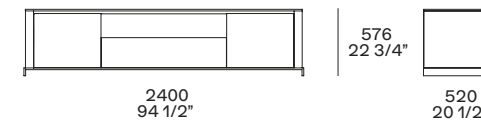

Due ante battenti, un cassetto e un vano a giorno.
Two leaf doors, one drawer and one open compartment.

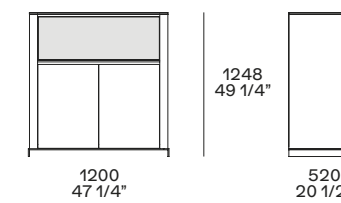

Un'anta a ribalta e due ante battenti per un unico vano.
One flap door and two leaf doors for one single compartment.

PANDORA

Jean-Marie Massaud disegna una collezione di madie dall'aspetto contemporaneo e versatile. Quattro i modelli di Pandora, tutti caratterizzati dalla combinazione di ante e cassetti e dai particolari piedini in metallo. Pressoché infinite le possibilità estetiche, con struttura e ante da personalizzare scegliendo tra tutti i colori laccati opachi e lucidi e le diverse essenze.

Jean-Marie Massaud designs a collection of sideboards with a contemporary and versatile look. Four are the models of Pandora, all characterized by the combination of doors and drawers and by the particular metal feet. The aesthetic possibilities are nearly infinite, with customizable structure and doors with all the mat and glossy lacquered colours and the different woods.





Nella pagina precedente: madia Pandora in rovere spessart con piedini in brown nickel opaco. Poltrona Santa Monica con rivestimento sfoderabile in pelle Special 14 nero. In questa pagina: madia Pandora in rovere spessart con piedini in brown nickel opaco. Sedia Harmony con seduta in rovere spessart e struttura in cromo nero.

Previous page: Pandora sideboard in spessart oak with mat brown nickel feet. Santa Monica armchair with removable cover in leather Special 14 nero. This page: Pandora sideboard in spessart oak with mat brown nickel feet. Harmony chair with spessart oak seat and black chrome structure.

In questa pagina: madia Pandora laccato bianco lucido con interno struttura laccato opaco roccia e piedini in brown nickel opaco. Nella pagina successiva: madia Pandora in olmo nero con interno struttura laccato opaco carbone e piedini in brown nickel lucido.

This page: bianco glossy lacquered Pandora sideboard, roccia mat lacquered inner structure and mat brown nickel feet. Next page: Pandora sideboard in black elm with carbone mat lacquered inner structure and glossy brown nickel feet.







In questa pagina: madia Pandora in rovere spessart con ante e cassetti laccato lucido visone e piedini in brown nickel lucido. Interno struttura laccato opaco visone. Sotto: dettaglio del cassetto con attrezzatura opzionale in rovere spessart e fondo in tecnopelle 05 latte. Nella pagina successiva: madia Pandora in rovere spessart con interno struttura laccato opaco muschio.

This page: Pandora sideboard in spessart oak with visone glossy lacquered doors and drawers, feet in glossy brown nickel. Visone mat lacquered inner structure. Below: close up of the drawer with optional equipment in spessart oak and drawer bottom in techno leather 05 latte. Next page: Pandora sideboard in spessart oak with muschio mat lacquered inner structure.





PANDORA

Design Jean-Marie Massaud, 2012

Struttura esterna e frontali laccato opaco colori, laccato lucido colori, rovere spessart o olmo nero. La struttura può avere una finitura diversa dai frontali.

Interno struttura in laccato opaco colori. Piedini in metallo verniciato brown nickel opaco o lucido.

Attrezzature: ripiani nei vani con ante.

Attrezzature opzionali medie Pandora basse: attrezzature per cassetto in rovere spessart con fondo cassetto in tecnopelle colori.

External structure and fronts mat lacquered colours, glossy lacquered colours, spessart oak or black elm.

The structure can be in a different finish than the fronts. Inner structure in mat lacquered colours. Feet in mat or glossy brown nickel painted metal.

Equipment: shelves behind the doors.

Optional equipment for low Pandora sideboard: equipment for drawer in spessart oak, drawer bottom in techno leather in the available colours.

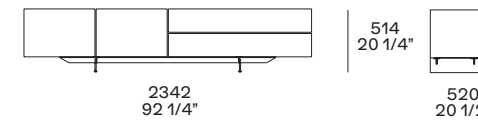

Due ante battenti e due cassetti.
Two leaf doors and two drawers.

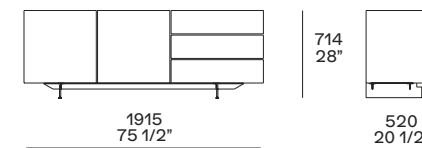

Due ante battenti e tre cassetti.
Two leaf doors and three drawers.

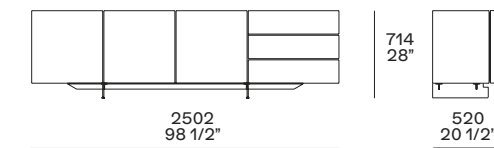

Tre ante battenti e tre cassetti.
Three leaf doors and three drawers.

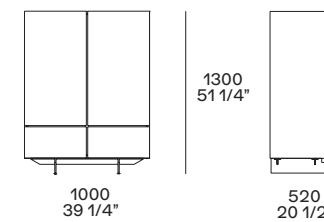

Due ante battenti e due cassetti.
Two leaf doors and two drawers.

BRISTOL

Bristol System è una collezione di complementi che si sviluppa a partire da un modulo contenitore attrezzabile con cassetti, vani a giorno e vani chiusi da un'anta a ribalta. Un sistema ideale per la zona giorno, da usare sia a parete sia a centro stanza.

Bristol System is a collection of complements that develops from a storage module that can be equipped with drawers, open compartments, and compartments closed by a flap door. An ideal system for the day area, to be used either at the wall or in the middle of the room.





Nella pagina introduttiva: madia Bristol in rovere spessart, inserti e piedini in brown nickel opaco, vani a giorno e contenitori laccato opaco carbone. Nella pagina precedente: madie Bristol laccato lucido visone, inserti e piedini in brown nickel opaco e contenitori in rovere spessart. Qui e nella pagina successiva: madia Bristol in olmo nero con interno struttura laccato lucido visone, inserti e piedini in brown nickel lucido, contenitore in olmo nero.

Introduction page: Bristol sideboard in spessart oak, inlays and feet in mat brown nickel, carbone mat lacquered open compartments and storage units. Previous page: visone glossy lacquered Bristol sideboards, inlays and feet in mat brown nickel and storage units in spessart oak. This and next page: Bristol sideboard in black elm with visone glossy lacquered inner structure, inlays and feet in glossy brown nickel, storage unit in black elm.

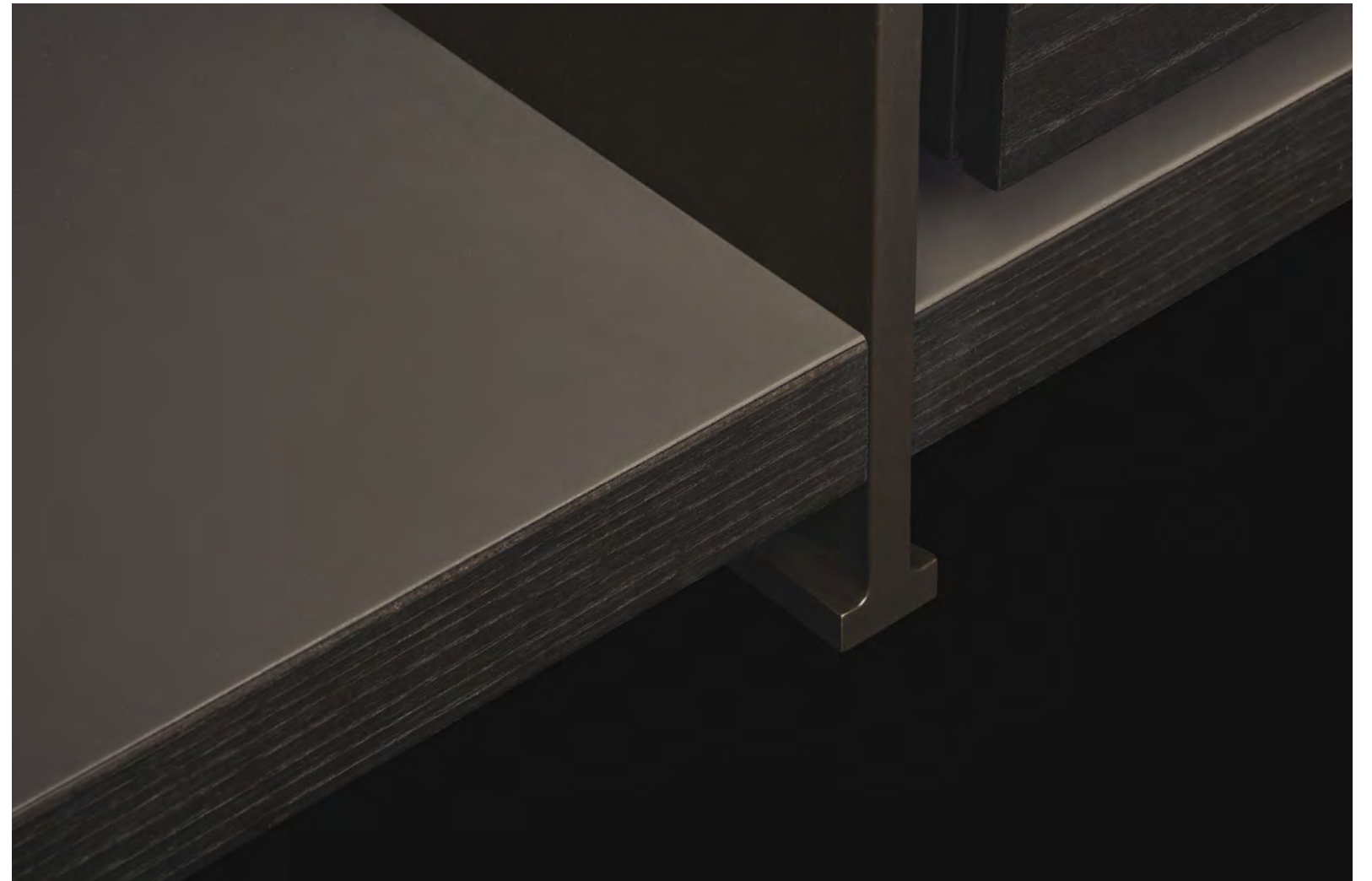





A sinistra: madia Bristol in rovere spessart, inserti e piedini in brown nickel opaco, vani a giorno e contenitori laccato opaco piombo. Divano Bristol in tessuto sfoderabile Rabat 412 cemento e cuscino in velluto Persia 1403 ocra, tavolini retrodivano Bristol in rovere spessart. Sotto: dettaglio top madia Bristol attrezzato con canalina passacavi.

Left: Bristol sideboard in spessart oak, inlays and feet in mat brown nickel, piombo mat lacquered open compartments and storage units. Bristol sofa in removable fabric Rabat 412 cemento and cushion in velvet Persia 1403 ocra, Bristol small tables to the back of the sofa in spessart oak. Below: close up of the top of Bristol sideboard arranged with cable passage.

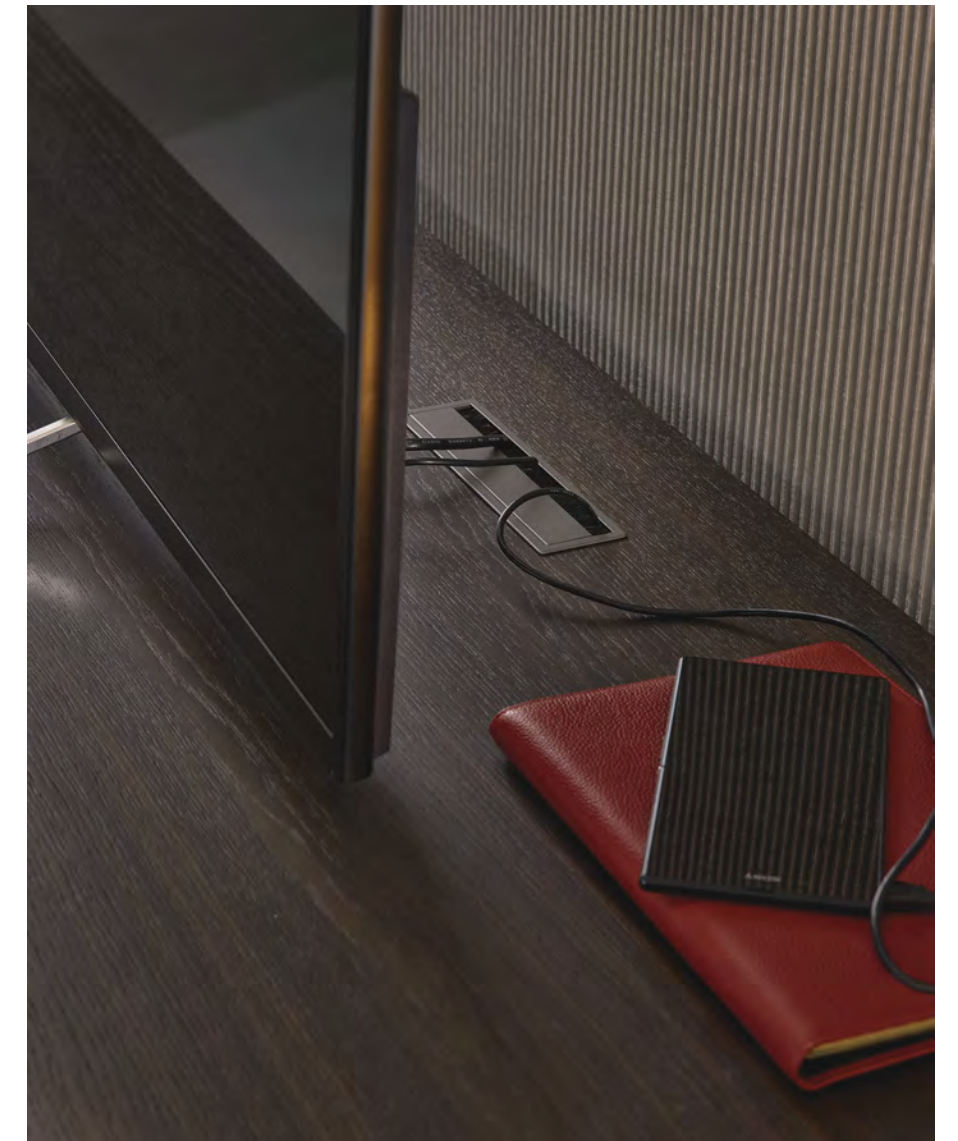

BRISTOL SYSTEM

Design Jean-Marie Massaud, 2014

Serie di madie disponibili in due altezze e attrezzabili con una serie di contenitori. Struttura esterna e interna in laccato opaco colori, laccato lucido colori, rovere spessart o olmo nero. Disponibili anche con struttura esterna in rovere spessart o olmo nero e interno struttura in laccato lucido colori. Inserti e piedini in alluminio verniciato brown nickel opaco o lucido. Contenitori in laccato opaco colori, rovere spessart o olmo nero. Le madie possono essere predisposte con tappi o canaline passacavi e ripetitore di telecomandi inseribile nei contenitori con anta a ribalta.

Series of sideboards available in two heights accessorized with several storage units. Outer and inner structure available in mat lacquered colours, glossy lacquered colours, spessart oak or black elm. Available also with outer structure in spessart oak or black elm and inner structure in glossy lacquered colours. Inlays and feet in mat or glossy brown nickel painted aluminium. Storage units available in mat lacquered colours, spessart oak or black elm. The sideboards can be arranged with cable passage and relay for remote controls to be mounted in the storage units with flap door.

Madie con vani a giorno attrezzabili Sideboards with open compartments to be accessorised

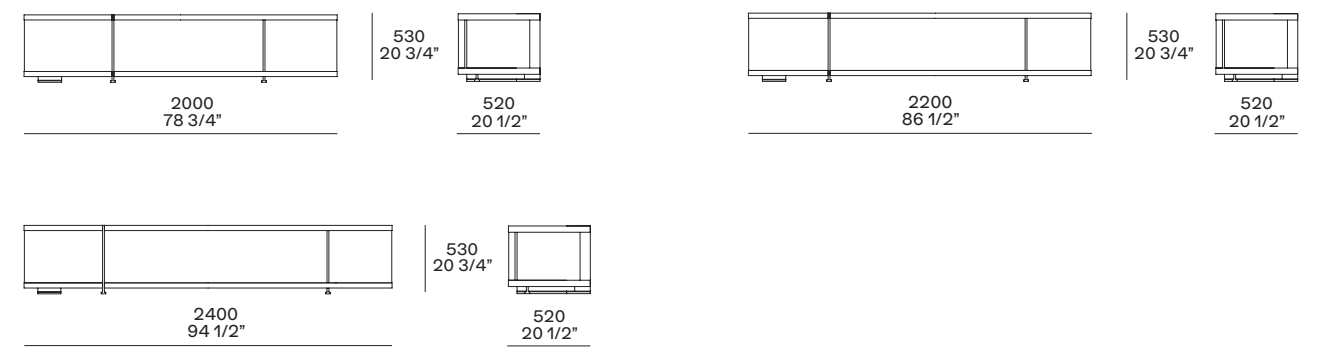

Contenitori Storage units



Anta a ribalta con ripiano interno o cassetto con vassoio estraibile.
Flap door with inner shelf or drawer with extractable tray.

Contenitore a giorno.
Open storage unit.

Madie con vani a giorno attrezzabili sx Sideboards with open compartments to be accessorised left

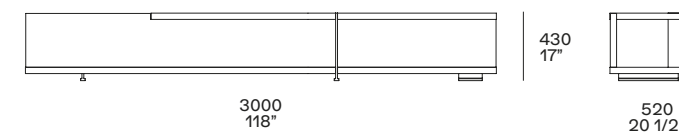

Madie con vani a giorno attrezzabili dx Sideboards with open compartments to be accessorised right

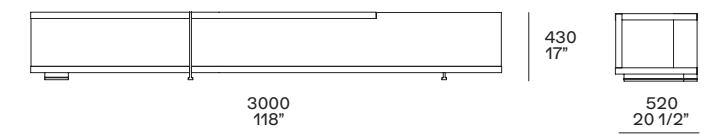

Madie con vani a giorno attrezzabili Sideboards with open compartments to be accessorised

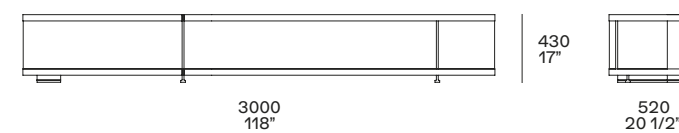

Contenitori Storage units

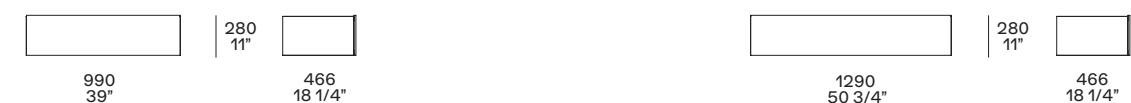

Anta a ribalta o cassetto.
Flap door or drawer.

Anta a ribalta o cassetto.
Flap door or drawer.

In questa pagina: libreria Bristol in rovere spessart, montanti verticali, inserti e piedini in metallo verniciato brown nickel opaco.

This page: Bristol bookcase in spessart oak, vertical columns, inlays and feet in mat brown nickel painted metal.



In questa pagina: libreria Bristol in laccato opaco roccia, montanti verticali, inserti e piedini in metallo verniciato brown nickel lucido.

This page: Bristol bookcase in mat lacquered roccia, vertical columns, inlays and feet in glossy brown nickel painted metal.





In questa pagina: libreria Bristol in olmo nero, montanti verticali, inserti e piedini in metallo verniciato brown nickel opaco, contenitore con anta a ribalta in olmo nero.

This page: Bristol bookcase in spessart oak, vertical columns, inlays and feet in mat brown nickel painted metal, storage units in black elm with flap door.



BRISTOL SYSTEM

Design Jean-Marie Massaud, 2014

Collezione di librerie disponibili in quattro larghezze e tre altezze con la possibilità di inserire in alcuni vani una serie di contenitori.

Struttura librerie in laccato opaco colori, laccato lucido colori, rovere spessart o olmo nero. Montanti verticali, inserti e piedini in alluminio verniciato brown nickel opaco o lucido. Contenitori in laccato opaco colori, rovere spessart o olmo nero.

Collection of bookcases available in four widths and three heights with the possibility of inserting storage units in the open compartments. Bookcase structure in mat lacquered colours, glossy lacquered colours, spessart oak or black elm. Vertical columns, inlays and feet in mat or glossy brown nickel painted aluminium. Storage units in mat lacquered colours, spessart oak or black elm.

Librerie h 775 Bookcases h 775 - 30 1/2"

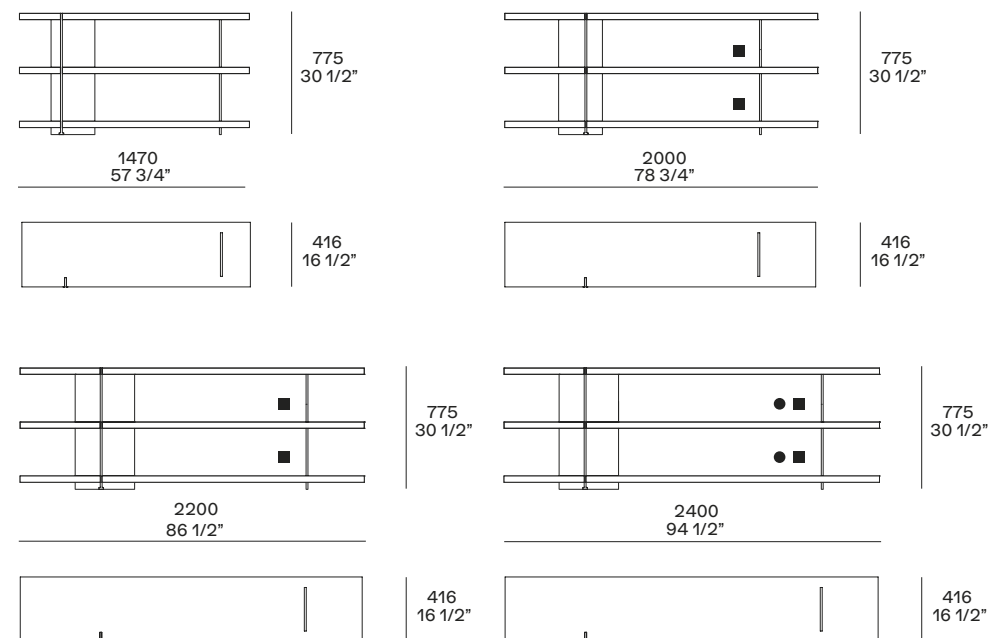

Contenitori Storage units



Anta a ribalta o cassetto.
Flap door or drawer.

Anta a ribalta o cassetto.
Flap door or drawer.

É possibile inserire i contenitori solo nei vani indicati.
It is possible to insert storage units only in the recommended spaces.

Librerie h 1120 Bookcases h 1120 - 44"

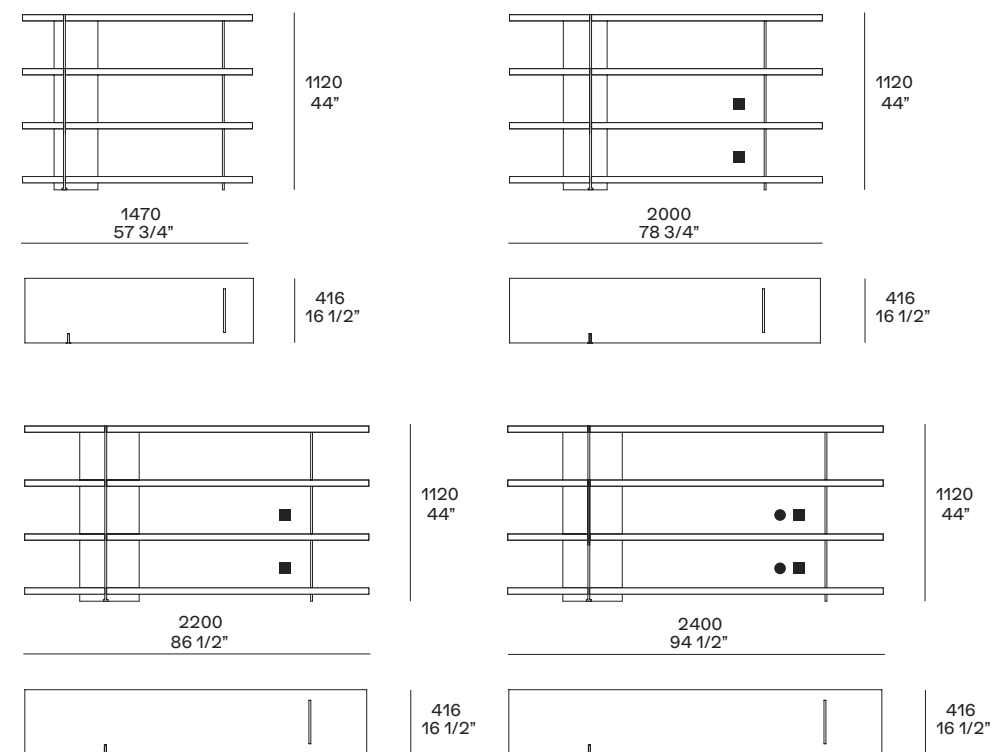

Librerie h 775 Bookcases h 775 - 30 1/2"

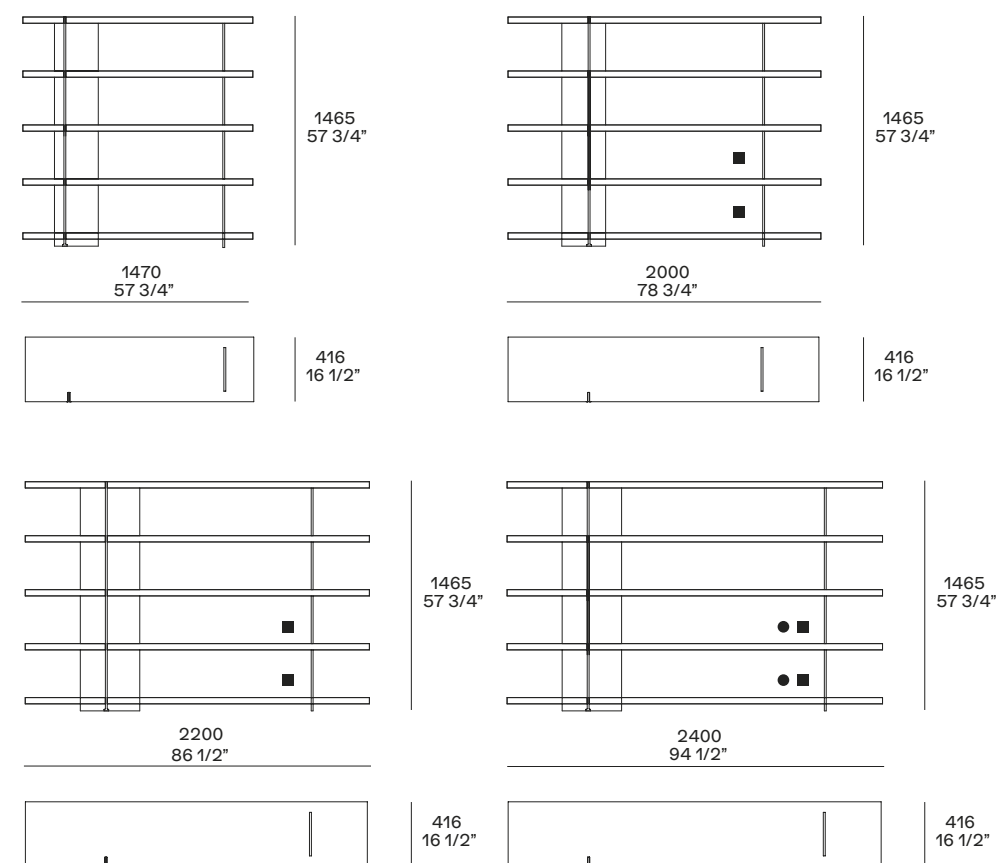



GIÒ

Rodolfo Dordoni disegna una madia di grande eleganza, tra storia e memoria, dove i dettagli sono protagonisti. Un design carico di suggestioni, fatto di volumi dal sapore antico, sapienti angolature e combinazioni di materiali di pregio come il legno e il marmo. La madia Giò è disponibile in versione alta o bassa.

Rodolfo Dordoni designs a very elegant sideboard, between history and memory, where the details are the protagonists. A design full of charm, made of volumes of an ancient flavour, skilful angles, and combinations of precious materials such as wood and marble. The sideboard Giò is available in high or low version.



Nella pagina precedente: madia Giò in olmo nero con top laccato lucido arena e spallette interne fianchi struttura verniciato brown nickel opaco. In questa pagina: madia Giò laccato lucido vischio con top in marmo calacatta oro lucido e spallette interne fianchi struttura verniciato brown nickel opaco. Interno struttura in olmo nero. Cassetti interni con frontale in laccato lucido vischio, fondo in tecnopelle 05 latte e attrezzatura opzionale in rovere spessart.

Previous page: Giò sideboard in black elm with arena glossy lacquered top and inner side of the structural side panels mat painted brown nickel. This page: vischio glossy lacquered Giò sideboard with top in glossy marble calacatta oro, inner side of the structural side panels mat painted brown nickel. Inner structure in black elm. Inner drawers with vischio glossy lacquered front, drawer bottom in techno leather 05 latte and optional accessories in spessart oak.







Nella pagina precedente: madia Giò laccato lucido moka con top in marmo calacatta oro levigato e spallette interne fianchi struttura verniciato brown nickel opaco. Interno struttura in olmo nero. In questa pagina: madia Giò in olmo nero e spallette interne fianchi struttura verniciato brown nickel opaco. Interno struttura in olmo nero. Sotto: dettaglio del cassetto interno con frontale in laccato opaco carbone, fondo in tecnopelle 05 latte e attrezzatura opzionale in rovere spessart.

Previous page: moka glossy lacquered Giò sideboard with top in marble calacatta oro and inner side of the structural side panels mat painted brown nickel. Inner structure in black elm. This page: Giò sideboard in black elm and inner side of the structural side panels mat painted brown nickel. Inner structure in black elm. Below: close up of the inner drawer with carbone mat lacquered front, drawer bottom in techno leather 05 latte and optional accessories in spessart oak.

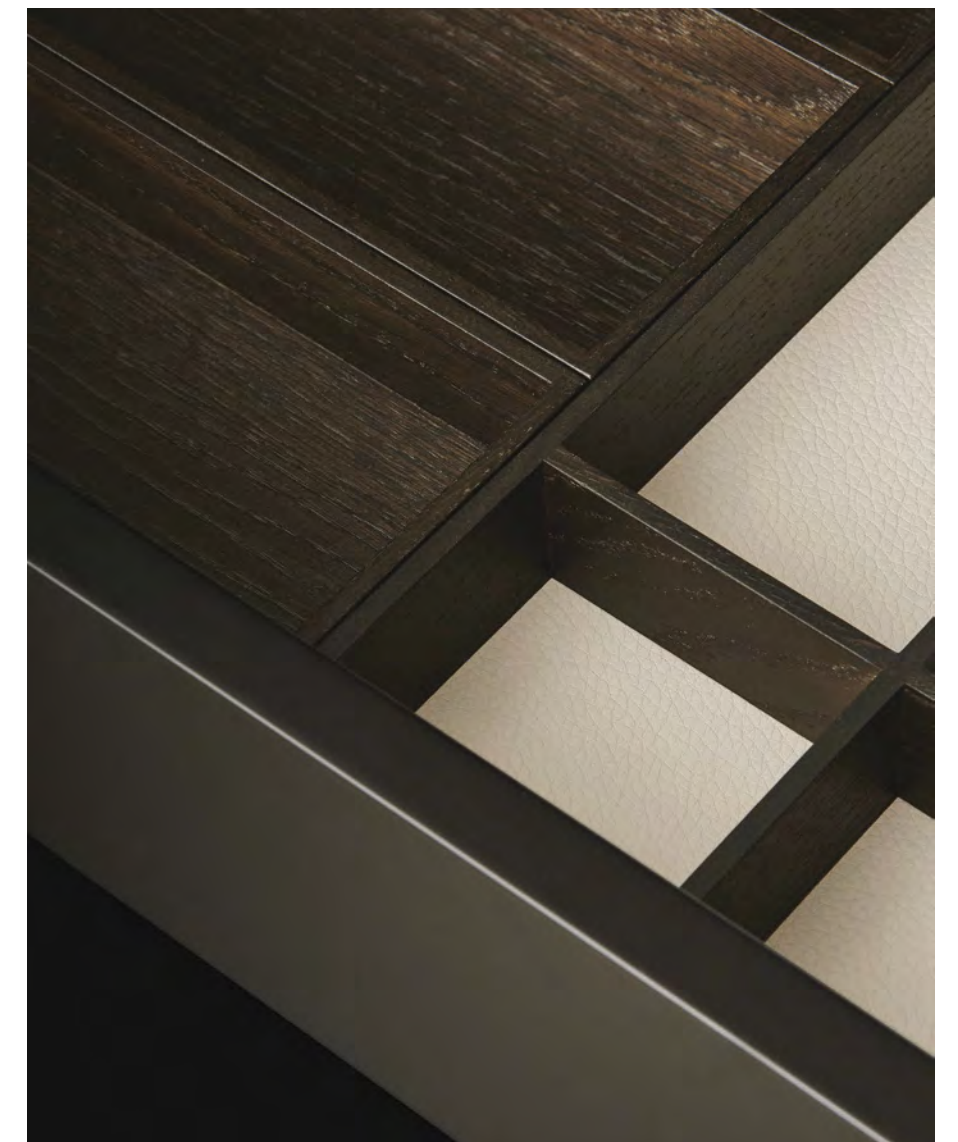

Qui e nella pagina successiva: madia Giò laccato lucido arena con top in olmo nero e spallette interne fianchi struttura verniciato brown nickel opaco. Interno struttura in olmo nero, ripiano in vetro fumé con schienale a specchio bianco e luce led integrata. Cassetti interni con frontale laccato lucido arena, fondo in tecnopelle 02 moro e attrezzatura opzionale in rovere spessart. Vassoio asportabile opzionale in laccato opaco gommato colore arena. Sedie Ipanema con e senza braccioli, rivestimento non sfoderabile in pelle Special 66 cedro, struttura in olmo nero. Tappeto Frame grey.

This and next page: arena glossy lacquered Giò sideboard with top in black elm and inner side of the structural side panels mat painted brown nickel. Inner structure in black elm, shelf in fume glass with white mirror back and integrated led light. Inner drawers with arena glossy lacquered front, bottom in techno leather 02 moro and optional accessories in spessart oak. Removable optional tray in rubberized mat lacquer colour arena. Ipanema chairs with and without armrests, non-removable cover in leather Special 66 cedro, black elm structure. Carpet Frame grey.





GIÒ

Design Rodolfo Dordoni, 2016

Struttura esterna e frontali in olmo nero, laccato opaco colori o laccato lucido colori. Top in olmo nero, laccato opaco colori, laccato lucido colori, cinque marmi levigati e sei lucidi. Spallette interne fianchi struttura verniciato brown nickel opaco o lucido. Interno struttura in olmo nero.

Attrezzature madia Giò bassa: vano a sinistra un cassetto in olmo nero, vano doppio a destra un ripiano in vetro fumé. Attrezzature opzionali madia Giò bassa: vano a sinistra cassetti in olmo nero, vassoio estraibile in olmo nero, attrezzature per cassetto in rovere spessart con fondo cassetto in tecnopelle colori.

Attrezzature madia Giò alta: luce led integrata, schienale a specchio bianco, ripiano in vetro fumé, due cassetti con frontali laccato opaco colori o laccato lucido colori con fondo in tecnopelle colori.

Attrezzature opzionali madia Giò alta: vassoio asportabile in laccato opaco colori gommatto, attrezzature per cassetto in rovere spessart.

External structure and fronts in black elm, mat lacquered colours or glossy lacquered colours. Top in black elm, mat lacquered colours, glossy lacquered colours, five mat and six glossy marble finishes. Inner side of the structural side panels mat or glossy painted brown nickel. Inner structure in black elm.

Equipment Giò sideboard, low version: left compartment with drawers in black elm, extractable tray in black elm, accessories for drawer in spessart oak, drawer bottom in techno leather in the available colours. Equipment Giò sideboard, high version: integrated led light, back in white mirror, shelf in fume glass, two drawers with fronts in glossy lacquered colours or glossy lacquered colours with bottom in techno leather in the available colours.

Optional accessories for Giò high sideboard: removable tray in rubberized mat lacquered colours, accessories for drawers in spessart oak.

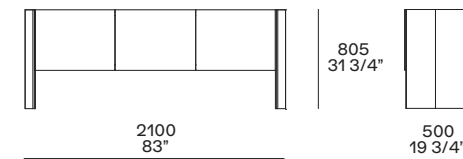

Tre ante battenti. Vano singolo a sinistra, vano doppio a destra.
Three leaf doors. Single compartment on the left, double.

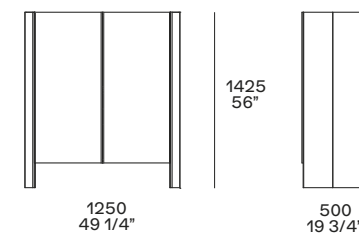

Due ante battenti, un unico vano.
Two leaf doors, one compartment.

THECA

Disegnata da Marcel Wanders, la madia Theca è un contenitore dal design rigoroso, reso unico dal contrasto di pieni e vuoti e dalla combinazione tra le superfici testurizzate laccato metallico della madia e quelle trasparenti della teca.

Designed by Marcel Wanders, the sideboard Theca is a storage unit with a rigorous design, made unique by the contrast of full and empty spaces and the combination between the textured metal lacquered surfaces of the sideboard and the transparent ones of the display case.



Nella pagina precedente: madia Theca laccato metallico bronzo con ante e cassetto in olmo nero, teca con due ripiani in vetro fumé. Sedie Sophie con braccioli, rivestimento non sfoderabile in pelle Soft 04 cognac, struttura in olmo nero. Tavolo Home Hotel con struttura e piano in olmo nero. Tappeto Tratto. In questa pagina: madia Theca laccato metallico bronzo con ante e cassetto in olmo nero, teca con due ripiani in vetro fumé. Interno struttura laccato opaco bronzo.

Previous page: Theca sideboard in bronzo metal lacquer with doors and drawer in black elm, glass case with two shelves in fumé glass. Sophie chairs with armrests, non-removable cover in leather Soft 04 cognac, black elm structure. Home Hotel table with structure and top in black elm. Carpet Tratto. This page: Theca sideboard in bronzo metal lacquer with doors and drawer in black elm, glass case with two shelves in fumé glass. Bronzo mat lacquered inner structure.





In questa pagina: madia Theca laccato metallico bronzo e teca con due ripiani in vetro fumé. Interno struttura laccato opaco bronzo. Nella pagina successiva: madia Theca laccato metallico bronzo con ante in olmo nero, teca in vetro fumé.

This page: Theca sideboard in bronzo metal lacquer and glass case with two glass shelves in fumé glass. Bronzo mat lacquered inner structure. Next page: Theca sideboard in bronzo metal lacquer with doors in black elm, glass case in fumé glass.





THECA

Design Marcel Wanders, 2018

Struttura laccato metallico ottone o bronzo. Frontali in laccato metallico ottone e bronzo o in olmo nero. Teca in vetro fumé. Interno struttura in laccato opaco ottone o bronzo. Attrezzature: ripiani in vetro fumé nei vani con ante, tre cassetti a estrazione totale in laccato opaco ottone o bronzo con frontale in vetro fumé nel vano a destra. Attrezzature opzionali: luce led, divisori per cassetto in tecnopelle 01 elefante.

Structure in metal lacquer ottone or bronzo. Fronts in metal lacquer ottone and bronzo or in black elm. Glass case in fumé glass. Inner structure mat lacquered ottone or bronzo. Equipment: shelves in fumé glass behind the doors, three drawers with full extension glides mat lacquered ottone or bronzo with front in fumé glass in the right compartment. Optional accessories: led light, partitions for drawer in techno leather 01 elefante.

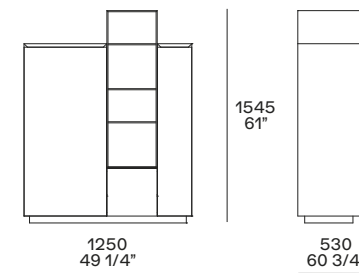

Due ante battenti, teca in vetro e un cassetto.
Two leaf doors, glass case and one drawer.

TECHNICAL DATA

TAPPETI
CARPETS

472

FINITURE
FINISHINGS

476

INDICE PRODOTTI
PRODUCT INDEX

482

TAPPETI
CARPETS

Frame

Prodotto a mano con tecnica handloom.
Trama in cotone, vello in seta di bambù.
Bordo perimetrale di 80 mm in lana
himalayana in tinta solo per la versione
rettangolare.
Dimensioni mm: rettangolare 1700x2400
2300x3000 - 3000x4000
quadrato 3000x3000 - ovale 2300x4000.

Handmade with the handloom technique.
Cotton weave, fleece in bamboo silk.
80 mm - 3 1/4" perimeter edge in Himalayan
wool in matching color only for the
rectangular version.
Dimensions inches: rectangular 67"x94 1/2"
90 1/2"x118" - 118"x157 1/2"
square 118"x118" - oval 90 1/2"x157 1/2".



Grey



Gold



Perla



Oceano



Prugna



Carbone



Plain

Prodotto a mano con tecnica handloom.
Trama in cotone, vello in aloe e seta di bambù.
Versione rettangolare bordo di 150 mm in
tonalità più scura sul lato superiore e inferiore
e di 100 mm per la dimensione 1700x2400.
Nella versione tonda la parte più scura è di
1/4 del tappeto.
Dimensioni mm: rettangolare 1700x2400
2300x3000 - 3000x4000
quadrato 3000x3000 - rotondo Ø 2500.

Handmade with the handloom technique.
Cotton weave, fleece in aloe and bamboo silk.
Rectangular version 150 mm - 6" edge in
darker colour in the upper and lower side and
100 mm - 4" edge for the size 1700x2400. In
the round version the darkest part is 1/4
of the carpet.
Dimensions inches: rectangular 67"x94 1/2"
90 1/2"x118" - 118"x157 1/2"
square 118"x118" - round Ø 94 1/2".



Tortora

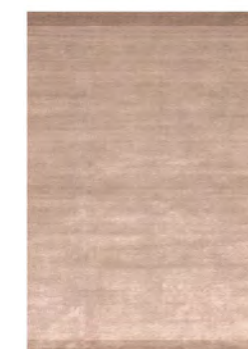

Cipria

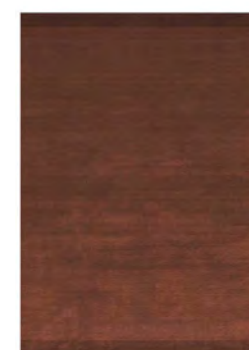
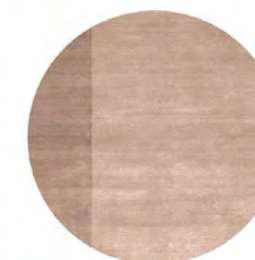

Ruggine

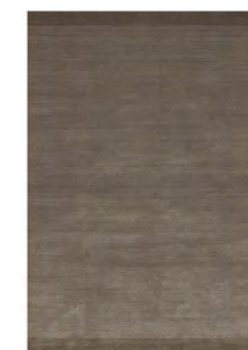

Arena



Natural



TAPPETI CARPETS

Dama

Prodotto a mano con tecnica handloom.
Trama in cotone, vello in lana himalayana e seta di bambù.
Dimensioni mm: rettangolare 1100×3500
1700×2400 - 2300×3000 - 3000×4000
quadrato 3000×3000.

Handmade with the handloom technique.
Cotton weave, fleece in Hymalayan wool and bamboo silk.
Dimensions inches: rectangular 43 1/4"x137 1/4" - 67"x94 1/2" - 90 1/2"x118" - 118"x157 1/2" square 118"x118".



Soft

Prodotto a mano con tecnica handloom.
Trama in cotone, vello in seta di bambù grigio sfumato.
Dimensioni mm: rettangolare 1700×2400
2300×3000 - 3000×4000
quadrato 3000×3000.

Handmade with the handloom technique.
Cotton weave, fleece in bamboo silk shaded grey.
Dimensions inches: rectangular 67"x94 1/2" - 90 1/2"x118" - 118"x157 1/2" square 118"x118".



Stripes

Prodotto a mano con tecnica handloom.
Trama in cotone, vello in lana himalayana e seta di bambù.
Dimensioni mm: rettangolare 1100×3500
1700×2400 - 2300×3000 - 3000×4000
quadrato 3000×3000.

Handmade with the handloom technique.
Cotton weave, fleece in Hymalayan wool and bamboo silk.
Dimensions inches: rectangular 43 1/4"x137 1/4" - 67"x94 1/2" - 90 1/2"x118" - 118"x157 1/2" square 118"x118".



FINITURE
FINISHINGS

Laccato opaco e lucido
Mat and glossy lacquered

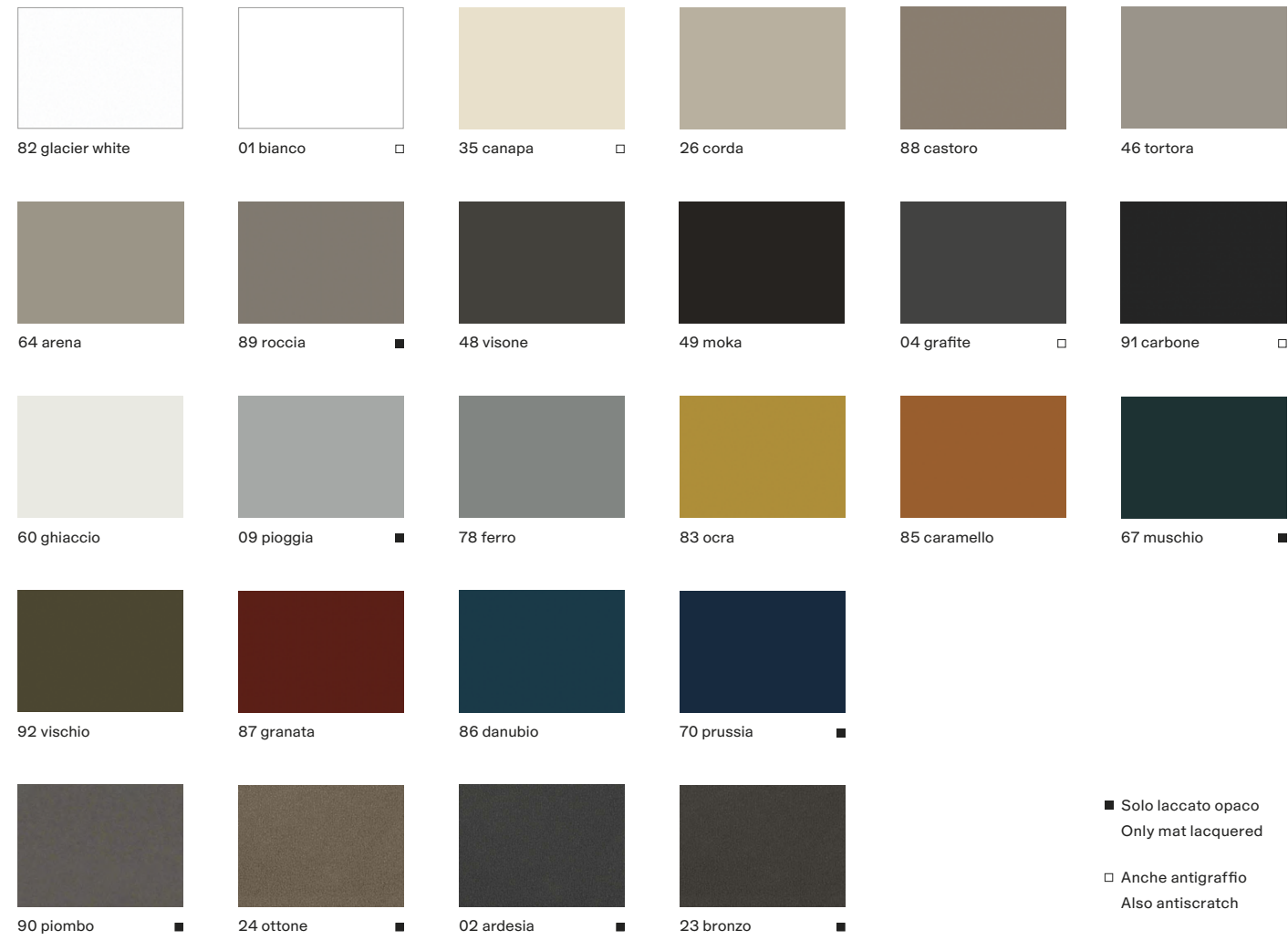

■ Solo laccato opaco
Only mat lacquered

□ Anche antigraffio
Also antiscratch

Laccato metallico
Metallic lacquered



Tecnopelle
Techno leather



Essenza
Wood

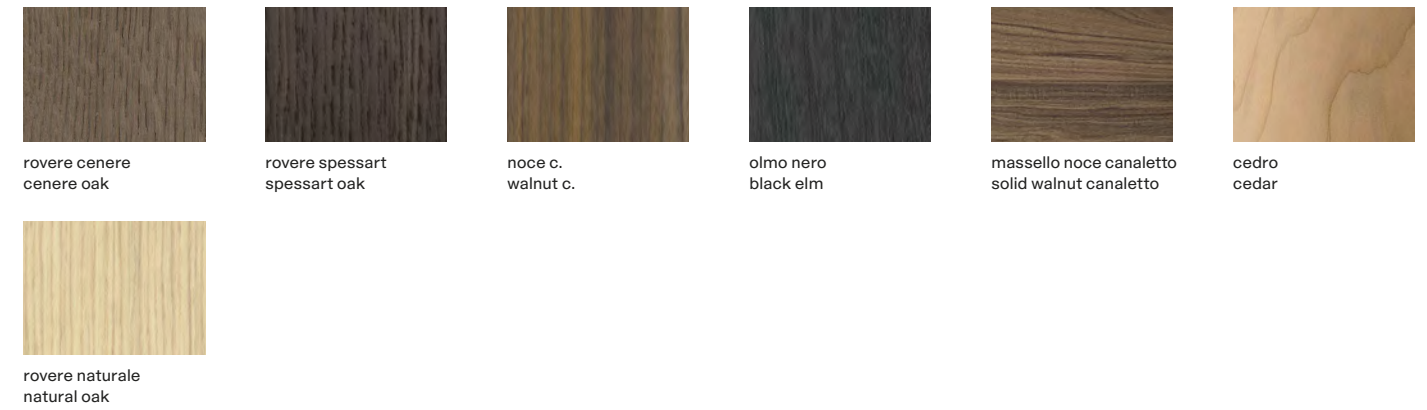

Nobilitato
Melamine

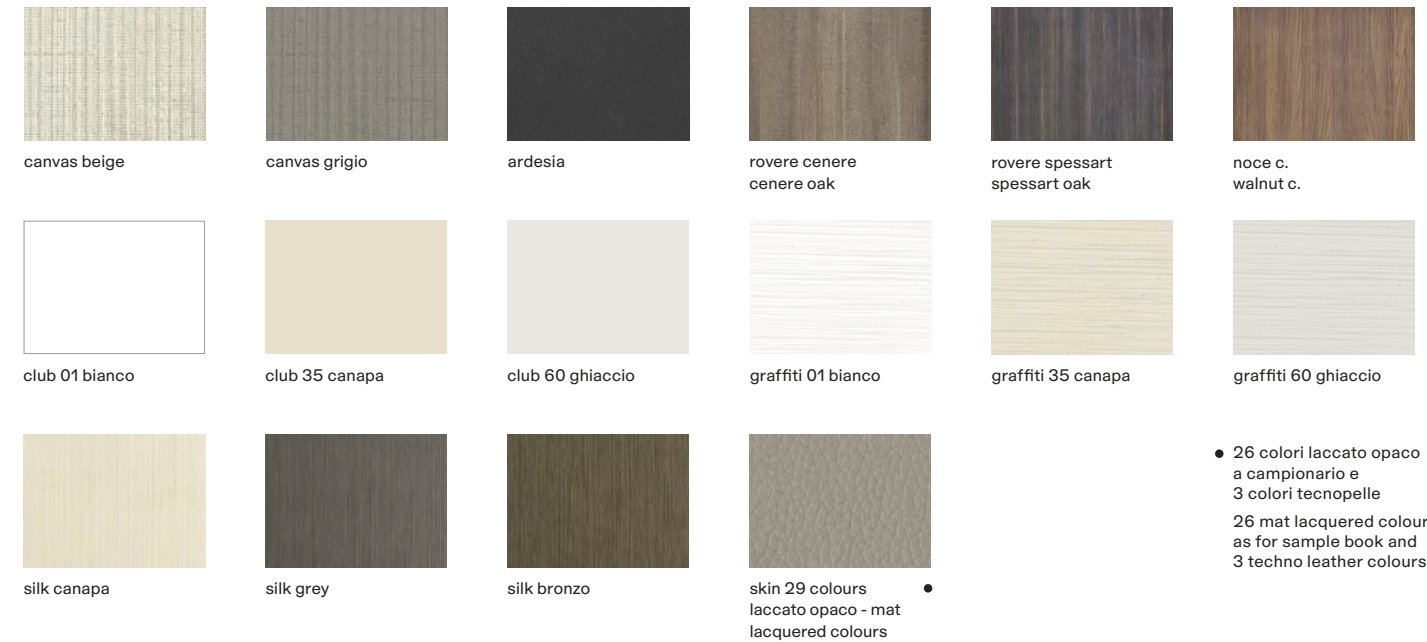

● 26 colori laccato opaco
a campionario e
3 colori tecnopelle
26 mat lacquered colours
as for sample book and
3 techno leather colours

Metacrilato
Methacrylate

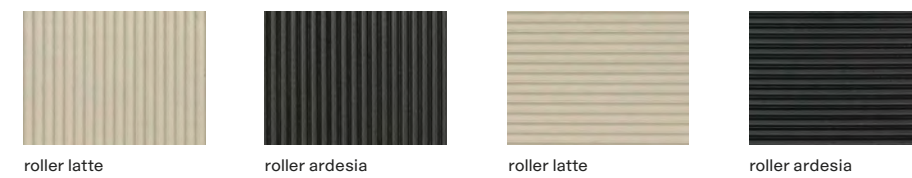

Nobilitato interno cassetti
Melamine drawers structure



FINITURE
FINISHINGS

**Vetro
Glass**



1000 trasparente
transparent



2000 trasparente
extrachiaro-transparent
extralight



3050 fumé

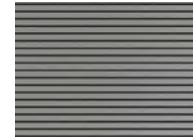

2700 line

**Vetro riflettente
Reflecting glass**

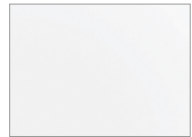

5000 trasparente
transparent

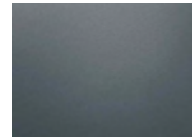

5010 blu



5051 bronzato
bronzed

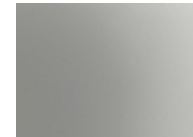

5059 fumé

**Vetro acidato
Etched glass**

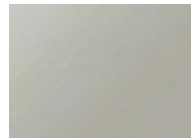

5380 acciaio

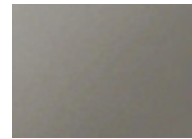

5323 bronzo

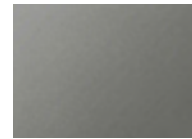

5325 titanio

**Specchio
Mirror**

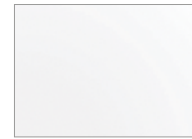

4000 bianco
white



4051 bronzato
bronzed

**Vetro satinato
Mat glass**

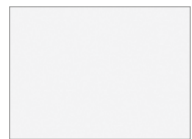

2301 bianco

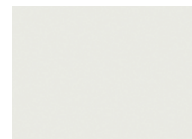

2373 ghiaccio

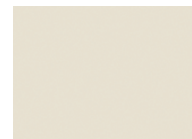

1335 canapa



1364 arena



1304 grafite



1303 nero

**Vetro lucido
Glossy glass**

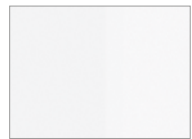

2201 bianco



2273 ghiaccio



1235 canapa



1264 arena



1204 grafite

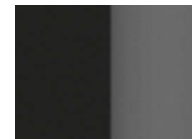

1203 nero

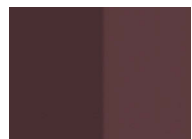

1259 bordeaux

**Marmo levigato
Mat marble**



bianco carrara



calacatta oro

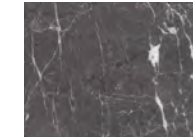

grigio stardust



emperador dark

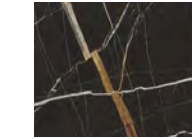

sahara noir
finitura poliestere
polyester finish

**Marmo lucido
Glossy marble**



bianco carrara



calacatta oro

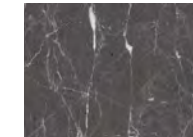

grigio stardust

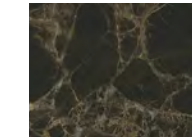

emperador dark



sahara noir
finitura poliestere
polyester finish

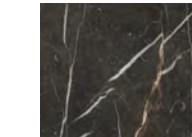

noir saint laurent

**Marmo e onice
Marble and onyx**



nero assoluto
texture juta

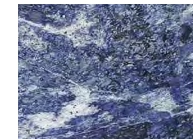

lapislazzulo blu
blue lapis lazuli



onice ambra
onyx amber

**Parti metalliche
Metal parts**

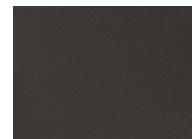

brown nickel opaco
mat brown nickel

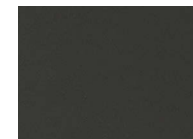

brown nickel lucido
glossy brown nickel

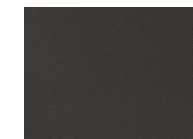

brown nickel satinato
brushed brown nickel



champagne opaco
mat champagne



champagne satinato
brushed champagne



cromo nero
black chrome



piombo
opaco - mat



ardesia
opaco - mat



bronzato
bronzed



bronzo anticato
antique bronze



oro lucido
glossy gold



alluminio brill
aluminium brill

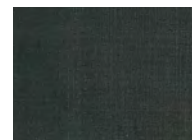

spatolato ferro
spatula-finish ferro

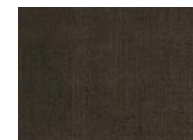

spatolato bronzo
spatula-finish bronzo

**FINITURE
FINISHINGS**

**Tessuti
Fabrics**

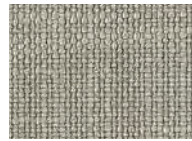

atlanta cat. b
12 colori - colours



chios cat. b
13 colori - colours

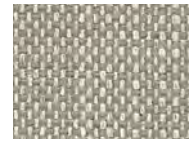

aspen cat. c
12 colori - colours

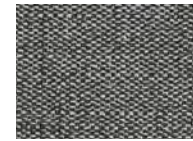

lima cat. c
11 colori - colours



saviglia cat. c
14 colori - colours



caledonia cat. d
9 colori - colours



cordoba cat. d
13 colori - colours



corinto cat. d
5 colori - colours



indra cat. d
12 colori - colours



itaca cat. d
10 colori - colours



kushiro cat. d
13 colori - colours



lipsi cat. d
11 colori - colours



milos cat. d
5 colori - colours



olimpia cat. d
14 colori - colours

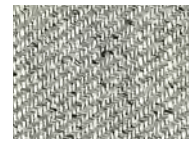

oxford cat. d
8 colori - colours



rabat cat. d
10 colori - colours



sendai cat. d
5 colori - colours



sparta cat. d
12 colori - colours



argo cat. e
13 colori - colours

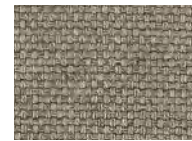

hannover cat. e
11 colori - colours

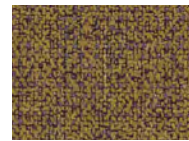

kitami cat. e
12 colori - colours



merida cat. e
8 colori - colours

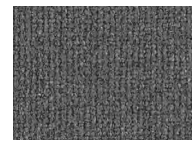

naxos cat. e
11 colori - colours



nayoro cat. e
10 colori - colours



norway cat. e
13 colori - colours



orleans cat. e
10 colori - colours



paros cat. e
11 colori - colours



persia cat. e
16 colori - colours

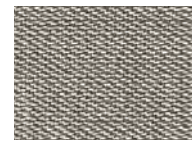

salford cat. e
11 colori - colours



skyros cat. e
12 colori - colours

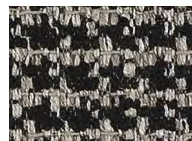

zante cat. e
11 colori - colours

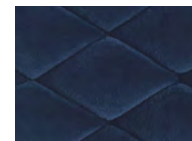

gibson cat. z
8 colori - colours

**Cuoio
Hide**



28 avorio



29 tortora



19 caffè



38 oliva

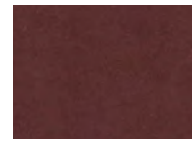

15 prugna



26 invecchiato



03 grigio scuro



02 nero

**Pelle
Leather**

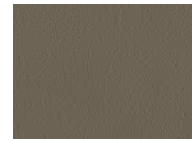

spring cat. p
13 colori - colours



colors cat. s
25 colori - colours



vintage cat. s
5 colori - colours



special cat. x
21 colori - colours

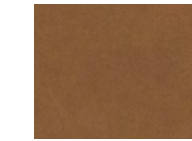

nabuk cat. y
10 colori - colours



nabuk intrecciata cat. y
woven leather nabuk
10 colori - colours

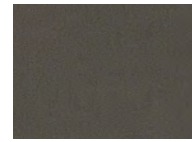

invecchiata cat. y
6 colori - colours



soft cat. y
14 colori - colours

**Pelle Cashmere
Cashmere leather**



bianco



grigio



nero

**Bordura gros-grain - bordura in seta - filati
Grosgrain border - silk border - yarns**



burro



perla



sahara

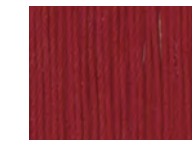

rubino

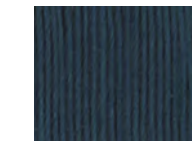

tempesta



navy



acciaio

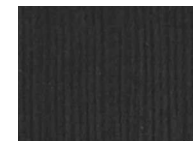

nero

● escluso bordura in seta
except silk border

**Provence coordinati letto
Bed linen Provence**

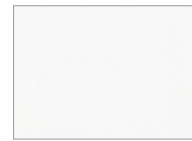

001 bianco



002 panna



008 polvere



004 tortora



006 roccia



007 grafite



003 ghiaccio

SEDIE
CHAIRS



Stanford Bridge, design Jean-Marie Massaud
pp. 10-21



Sophie, design Emmanuel Gallina
pp. 22-33



Grace, design Emmanuel Gallina
pp. 34-45



Ventura, design Jean-Marie Massaud
pp. 46-55



Ventura, design Jean-Marie Massaud
pp. 56-59



Mad Dining Chair, design Marcel Wanders
pp. 60-71



Ipanema, design Jean-Marie Massaud
pp. 72-83



Seattle, design Jean-Marie Massaud
pp. 84-95



Harmony, design Rodrigo Torres
pp. 96-103



Velvet, design R&D Poliform
pp. 104-111



Velvet Due, design R&D Poliform
pp. 112-115



Manta, design Rodrigo Torres
pp. 116-123



Guest, design Rodolfo Dordoni
pp. 124-131



BB, design Blumer e Borghi
pp. 132-139

PANCHE
BENCHES



Jane, design Emmanuel Gallina
pp. 144-151



Home Hotel, design Jean-Marie Massaud
pp. 152-159

SGABELLI
STOOLS



Sophie, design Jean-Marie Massaud
pp. 164-173



Ventura, design Jean-Marie Massaud
pp. 174-183



Harmony, design Rodrigo Torres
pp. 184-193



Ics - Ipsilon, design Rodrigo Torres
pp. 194-203

TAVOLI
TABLES



Kensington, design Jean-Marie Massaud
pp. 208-223



Concorde, design Emmanuel Gallina
pp. 224-239



Home Hotel, design Jean-Marie Massaud
pp. 240-255



Flute, design Roberto Barbieri
pp. 256-265



Howard, design Jean-Marie Massaud
pp. 266-277



Mad Dining Table, design Marcel Wanders
pp. 278-289



Opéra, design Emmanuel Gallina
pp. 290-301



Gill, design Roberto Barbieri
pp. 302-311



Blade, design R&D Poliform
pp. 312-323



Trevi, design Roberto Barbieri
pp. 324-331

SCRITTOI
DESKS



Mathieu, design Emmanuel Gallina
pp. 336-343



Home Hotel, design Jean-Marie Massaud
pp. 344-355



Concorde, design Emmanuel Gallina
pp. 356-363

CONSOLLE
CONSOLE



Home Hotel, design Jean-Marie Massaud
pp. 350-355

MADIE
SIDEBOARDS



Home Hotel, design Jean-Marie Massaud
pp. 368-381



Free, design Carlo Colombo
pp. 382-395



Febe, design Studio Kairos
pp. 396-409



Pandora, design Jean-Marie Massaud
pp. 410-423



Bristol, design Jean-Marie Massaud
pp. 424-437



Giò, design Rodolfo Dordoni
pp. 446-459

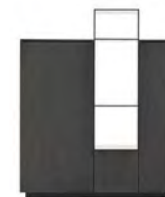

Theca, design Marcel Wanders
pp. 460-469

LIBRERIE
BOOKCASES



Bristol, design Jean-Marie Massaud
pp. 438-445

Poliform Spa

via Montesanto 28
Casella postale n. 1
22044 Inverigo (CO) Italy
t +39 031 6951
f +39 031 699444
info@poliform.it
poliform.it



2018 Adi Compasso D'oro
Career Award

Poliform realizza tutte le sue collezioni in Italia usando componenti e materie prime selezionate.

All the Poliform collections are manufactured 100% in Italy using top-class components and materials.

Poliform si riserva il diritto di apportare, senza preavviso, ogni modifica mirata al miglioramento funzionale e qualitativo dei propri prodotti. Testi e disegni presenti in questo stampato hanno scopo divulgativo: per ogni aspetto tecnico e dimensionale fare riferimento ai listini aziendali e relativi aggiornamenti. I campioni di colori e materiali hanno valore indicativo.

Poliform reserves the rights at all time to apply modifications for the functional or qualitative improvement of its products. Texts and drawings present in this brochure have a divulgative purpose: for every technical and dimensional aspect please refer to the company's price lists and their relative updatings. The colour and material samples have an indicative value.

Creative Direction

Apartamento Studios

Graphic Design

Apartamento Studios

Interiors Photography

Federico Cedrone, Omar Sartor

Still Life Photography

Silvia Orlandi

Interiors Styling

Poliform Lab

1st edition April 2019

cod. 106/R1/2019



ASSARREDO
FEDERLEGNOARREDO



TWO THOUSAND NINETEEN